

ERGOFIT

Qualität in Bewegung.



Owner's manual



STRESS ECHO X MED

STRESS ECHO X MED

STRESS ECHO X MED

CE 0297

Please read this manual carefully before use and keep it in a safe place for future reference

For further information about ERGO-FIT products please contact:

ERGO-FIT GmbH & Co. KG

Blocksbergstraße 165

66955 Pirmasens

Germany

Phone: +49 (6331) 2461-0

Fax.: +49 (6331) 2461-55

E-Mail: info@ergo-fit.de

<http://www.ergo-fit.de>

Development and production of all devices of the MED series according to the European Medical Device Directive 93/42/EWG. They thus show the CE marking and the number of the notified body.



© 2021 by ERGO-FIT GmbH & Co. KG. All rights reserved.

This user manual has been created with greatest possible diligence. Please inform us of any details that do not correspond to your training device so we can take care of this as quickly as possible.

This document is protected by copyright. All rights originating from this, particularly the right of copying, duplication, distribution as well as translation and reprint, even copies in extract, are reserved. No part of this manual may be reproduced, manifold or distributed for any purposes or in any form, by any means, (print, photocopy, microfilm, or any other information-saving mechanisms) without prior written permission of ERGOFIT GmbH & Co. KG.

Trade marks: ERGO-FIT and the ERGO-FIT Logo are registered trade marks of ERGO-FIT GmbH & Co. KG. POLAR is a registered trade mark of POLAR Electro GmbH. All other trademarks used/shown in this text are trademarks of their respective owners and are thus protected.

Technical and optical modifications as well as misprints reserved

Version: STRESS ECHO X MED-20210501-en

Printed in Germany

Dear customer,

Thank you for purchasing an ERGO-FIT training device. You are now the owner of a state-of-the-art training system that combines highest technical standards with easy-to-use functionality.

This user manual contains important information on how to operate and use STRESS ECHO X MED. We recommend that you read this user manual carefully before starting with your workout in order to become familiar with your training device quickly and to understand its correct and safe operation.

Should you have any further questions that are not answered in this manual, please contact us. ERGO-FIT will try to help as quickly as possible.

The ERGO-FIT team can also advise you on compatible ECG equipment.

Table of contents

1	General information	1
2	Safety instructions	5
3	Quick reference	13
4	Intended Use	15
5	Transport and Installation	17
6	Setup	23
7	Operation	39
8	Maintenance	55
9	Troubleshooting	61
A	Appendix	69

Chapter 1 General Information

1.1	STRESS ECHO X MED at a glance	2
1.2	General Information on this Manual	2
1.3	Parts included in the Delivery	3
1.4	Customer Service	3
1.5	Disposal	4

1 General Information

1.1 STRESS ECHO X MED at a glance

The multifunctional STRESS ECHO X MED is the combination of an adjustable examination couch and a tiltable ergometer. It allows for non-invasive cardiological diagnostics and all conventional ultrasonic examinations. The ergometer can be raised and operates with a fully electronic eddy current brake controlled by the software.

The 4-key cockpit of the clearly arranged display can be used to select various loading programs.

The quiet operation, ease of use and the consideration of customer-specific requirements demonstrate ERGO-FIT's focus: High technical standard, optimum workout environment and precise workout control, combined with user-friendly operation.

However, technology is not the only crucial factor for outstanding workout equipment. The machines must also meet biomechanical and medical requirements; it has to be developed by combining technical and electronic expertise with the latest results in sports medicine

Our STRESS ECHO X MED is composed of:

1. adjustable examination table
1. tiltable ergometer

The lifetime of the STRESS ECHO X MED is 6 years.

A list of compatible external equipment can be obtained from ERGO-FIT.

1.2 General Information on this Manual

Whether you are already familiar with ERGO-FIT workout equipment or whether you have not used our machines yet: This manual gives you important information.

You can easily find the information you are looking for by searching the table of contents. Users who are already familiar with ERGO-FIT equipment might find the Quick Reference helpful. However, if you are an experienced user and only rely on the Quick Reference please make sure that you nevertheless review the safety guidelines.

The manual contains many tips and tricks to help you get familiar with your cardio machine as quickly as possible.

Please always keep the manual at hand to avoid unnecessary and time-consuming calls at the customer service and to quickly fix problems on your own.

1.3 Parts included in the Delivery

Please check if all parts are included in the delivery and inform our sales department immediately of any missing parts.

Please ensure that the following parts are included in your delivery:

1. Examination table with seat, shoulder support, hip support, folding side pad, Paper role holder
2. Ergometer
3. Manual switch
4. Single open-end wrench SW 19
5. One power cord per machine

Please note that the interface cable is not included in the scope of delivery. It must be purchased separately.

1.4 Customer Service

Contact our customer service for troubleshooting services, technical support, spare parts delivery and information.

In case of technical questions and service orders, please call us at:

Head office:

Phone: +49 (6331) 2461-0

or +49 (6331) 2461-20

or +49 (6331) 2461-45

Fax: +49 (6331) 2461-55

1.5 Disposal

These machines are appliances according to the Electronic Equipment Act. They do not belong into the regular household waste but must be disposed of by a certified company. For more information on responsible bodies please see:

stiftung elektro-altgeräte register (EAR)

Benno-Strauß-Straße 1

D-90763 Fürth

Phone: +49 (911) 766650

Fax: +49 (911) 766650

Mail: info@stiftung-ear.de

Web: www.stiftung-ear.de

Chapter 2 Safety Instructions

2.1	What You Need to Know When Using your Workout Equipment	6
2.2	Instructions for Safe Operation	10
2.3	How to Avoid Electric Shocks	10
2.4	Choosing the Right Place of Installation	10
2.5	What Needs to be Considered in Case of Repair?	11
2.6	Things to be Avoided	11
2.7	Contraindications	11

2 Safety Instructions

Please read the following chapter carefully and respect all safety instructions before you start using your workout equipment. Please keep this manual in a safe place in order to pass it over to future owners if you sell your workout device.

For evidence of ownership, please complete the following form:

Model/series _____
 Serial number _____
 Date of purchase _____

You will need this information in case of warranty.

The following symbols designate important information.

	Caution!	This warning draws the attention to hazards that could result in personal injury or death.
	Warning!	This warning draws attention to hazards that could result in property damage.
	Attention!	Attention , Switch off and unplug the machine.
	Tip!	This hint contains important information and tips to improve operation.

2.1 What You Need to Know When Using your Workout Equipment

- ⊗ Carefully read this manual prior to using your product.
- ⊗ Familiarize yourself with the machine before you start your workout.
- ⊗ It's the owner's responsibility to inform the users of all warnings and instructions provided with the equipment.
- ⊗ Please consult your physician before you start using the machine and note the contraindications (see Chapter 2.7).
- ⊗ Before using the machine please perform a proper function test (see chapter 7.3). For safety reasons inspect the machine (loose screws, worn parts) and the power cord for signs of damage before each use. If the machine is damaged do not use it until it is repaired.

- ⊗ Warning! Do not exceed the maximum user weight of 200 kg.
- ⊗ Do not place any beverages or food on your training machine.
- ⊗ Before each use, check the device, accessories and cables for damage. Discontinue use if the device is damaged. Make sure that the pad in the right foot area - as viewed from the recumbent patient - is intact, since it covers the power supply. Don't operate the table if the pad is loose or defective.
- ⊗ Check whether all locking pins for the adjusting mechanisms and pads are locked before the patient uses the device
- ⊗ Tighten the pedals and the pedal cranks after 3 to 5 operating hours. Otherwise there is a risk of injury. Note that the left pedal has a left-handed thread and the right pedal has a right handed thread. For more detailed description, see Chapter 8.1
- ⊗ Do not take your feet off the pedals during training.
- ⊗ The machine is only to be used on instruction of a physician and / or a supervisor. The machine must not be used without the presence of a supervisor.
- ⊗ During transport, place connecting lines and other lines on top of the table in order to avoid possible damage due to lose lines. Ensure that the power cords cannot be driven over.
- ⊗ Do not touch the USB port, RS232 port or audio port or the connection for SPO₂ measurement during the training.
- ⊗ Do not lean on the control panel.
- ⊗ Lock the adjustable feet before using the table. The table may only be tilted if the adjustable feet are locked, in order to prevent instability and collision of the table top with the adjustable feet levers.
- ⊗ In order to avoid injuries, talk to the patient before adjusting the seat and maintain eye contact with the patient while adjusting the seat.
- ⊗ Adjust the seat, hip support, and the head and shoulder support in order to prevent crushing of the spinal column or other impairments to the patient.
- ⊗ Make sure that third parties do not stand close to moving parts.
- ⊗ Switch off the machine after the workout and disconnect it.
- ⊗ Attention! The following components of the training bike have dangerous nip and pinch points: drive unit, inclined head-rest and bed, improperly adjusted seat and seat post, improperly tightened components. This results in increased risk of injury.
- ⊗ Ensure that the shoulder support is folded up over the full swiveling range. Ensure that there is sufficient clear space beside the table for this purpose. The reclining area must not be operated when the support is folded up.
- ⊗ For safety reasons, please leave enough space around the machine for the user to move safely and to avoid that bystanders are hurt by moving parts:

Seen from the access orientation, maintain a clearance of at least the training space plus 0,6 m. Provide enough space for an emergency disassembly. Adjacent machines may use the same clearance

- ⊗ Your workout machine is not a toy! Children must be supervised if they are near the equipment. Children cannot always predict possible hazards. Parents or other supervisors should always be aware of their responsibility because the playful and adventurous nature of children may lead to situations that the workout machine is not intended for..
- ⊗ Please review the additional safety and operational instructions in this manual

All safety instructions in this manual are based on many years of experience and selfconception.

Blood Pressure:

- ⊗ The machine must not be used in hazardous areas. The blood pressure measuring machine must not be exposed to strong vibrations. It must be protected against moisture and dust. The machine may only be used in dry rooms.
- ⊗ The machine must be placed in such a way that it can be easily disconnected from the power supply. The machine can be disconnected at any time by unplugging the mains cable and enabling the safe mode.
- ⊗ The machine should not be operated in the immediate vicinity of strong alternating current fields and heat sources. Do not use the machine in the vicinity of HF surgery. Avoid strong ambient noise.
- ⊗ Cellular phones in the immediate vicinity can significantly interfere with the operation of the machine.
- ⊗ The cuff must not be placed on a limb to which an IV is connected. Inflating the cuff can interrupt the infusion process, which could jeopardize the patient's health.
- ⊗ In order for the blood pressure to be measured, the cuff must briefly suppress the blood flow in the limb. The pulse can no longer be measured below the cuff during the measurement process. The tube must not be bent in order to ensure proper flow. Measurements taken too frequently can result in circulatory disorders.
- ⊗ The blood pressure cuff must not be worn on the arm on the mastectomy side in order to prevent congestion and avoid disturbing the lymphatic flow.
- ⊗ The blood pressure measurement can be influenced by the position of the patient (lying, sitting, standing), by physiological exertion and by the emotions of the patient.

- ⊗ The METRONIK BL-6 should not be used in the following cases:
 - for patients who tend to bruise.
 - for patients who are expected to develop skin lesions.
 - if the cuff would have to be put on
 - injured skin
 - for newborn infants
- ⊗ According to the Medical Device Operator Ordinance, a metrological control must be carried out every 2 years at the latest. Calibration and repair can only be performed by the manufacturer, by METRONIK SUESS OHG or by a service provider authorized by METRONIK. An annual interval is recommended for the STK.
- ⊗ We would like to emphasize the fact that if some parts become worn or if they need to be repaired, only METRONIK BL-6 original spare parts must be used.

SPO₂-Module

- ⊗ Do not use this module near any MRT or X-ray devices.
- ⊗ Keep the SPO₂ module away from flammable gases.
- ⊗ Check all components of the SPO₂ module (finger clip, cables etc.) for damages. In case of damages do not use the device until it is repaired.
- ⊗ Keep the SPO₂ module away from any liquid as well as any condensations.
- ⊗ Nail polish or artificial nails can influence the SPO₂ measurement. Remove nail polish or artificial nails before using the sensors.
- ⊗ Taking medicine that changes the blood color, the administration of intravascular dyes or a high concentration of dysfunctional hemoglobin can lead to incorrect results.
- ⊗ Intense light such as OP lamps, bilirubin lighting, fluorescent lamps, infrared heat lamps and direct sun light can lead to incorrect SPO₂ results.
- ⊗ Using third-party parts can cause malfunction and loss of biocompatibility. Only use original parts and sensors.
- ⊗ Do not use the device if you suffer from edemas, skin irritations or have an open wound.

2.2 Instructions for Safe Operation

- ⊗ After delivery, make sure that the machine has not been damaged during transport. In case of doubt, contact our customer service and do not start the machine.
- ⊗ Slots and openings on the machine serve as ventilation. Do not cover these openings, because this can cause the components to overheat.
- ⊗ Always check the power cord for damages before starting the machine.
- ⊗ Switch off the machine after the workout and disconnect it.
- ⊗ Set the device up in an open space for easier operation, and in order to reduce possible sources of danger due to tilting and pivoting of the table top and due to the pedal movements.
- ⊗ Connect the protective earth conductors (yellow/green) of the training bike to the grounding point on the bed.
- ⊗ Equipment of the STRESS ECHO X MED, series are protected against harmful ingress of water and solid objects according to IP21.
- ⊗ For STRESS ECHO X MED the protection guidelines according to EN 60601-1:2006 apply.
- ⊗ If you connect additional devices to the STRESS ECHO X MED line you are committed to comply to the system standard EN 60601-1-1.

2.3 How To Avoid Electrical Shocks

- ⊗ Do not use damaged power cords.
- ⊗ Do not unplug by pulling on the cord.
- ⊗ Switch off and unplug the machine before you open it.
- ⊗ If liquid gets inside the machine, unplug the machine immediately and call the customer service.
- ⊗ Do not insert any objects in the ventilation slots. This may cause a short circuit.
- ⊗ Ensure that the power cords cannot be driven over.
- ⊗ Don't run the supply cable under the machine, neither between the mobile parts or devices of the machine. The insulation could be damaged unconsciously.
- ⊗ Warning! To avoid electric shocks these devices must only be connected to mains with protective earth conductors.

2.4 Choosing the Right Place of Installation

- ⊗ The machine can be set up on any level and stable floor. Make sure that it stands firmly on the floor.
- ⊗ Never put wood, cardboard or similar materials underneath the machine to compensate for unlevel surface. This increases the risk of accident.

2.5 What Needs to be Considered in Case of Repair?

- ⊗ Electric parts may only be replaced by original parts.
- ⊗ Repairs must be carried out by a qualified technician only. If you do not have the necessary qualifications, contact ERGO-FIT Service Center. Electrical or mechanical modifications or alterations performed by unauthorized personnel may void the warranty.
- ⊗ Do not open the drive system and control system. This will void the

2.6 Things to be Avoided

- ⊗ Only use the machine for the purposes it was intended for. If you use the ERGO-FIT device for other than the intended purpose, you will be charged for all damages resulting from this. In this case any warranty is void!
- ⊗ Never use the device in a manner other than that described in the user manual. Otherwise damage to the device and even damage to health could result.
- ⊗ Never use a damaged machine.
- ⊗ Do not use the machine without electricity.
- ⊗ Never lean on the machine and do not make inappropriate movements. Otherwise you might fall.
- ⊗ Don't pull on the pads while transporting the device. (see Chapter 5.1).
- ⊗ If the training bike has been lowered the adjustment devices may not be used.

Refer to the appendix for a list of the most important safety guidelines. Attach this list near the machine where it is clearly visible. All users of the machine must familiarize themselves with the dangers and safety regulations. The manufacturer will not be liable for personal injury or property damage.

2.7 Contraindications

To avoid overstress of the athlete and subsequent serious diseases of the cardiovascular system the following contraindications must be observed during performance of an endurance training, i.e. if one of the following symptoms is already known before the training is started in no case an endurance training may be performed on the STRESS ECHO X MED.

Absolute contraindications:

- ⊗ angina pectoris
- ⊗ cardiac arrhythmia and/or Decompensated heart failure
- ⊗ distress respiratory, sense of oppression
- ⊗ circulatory disorder with rest pain in affected extremities
- ⊗ hypertension (constantly raised blood pressure) (in this case, please contact your doctor)
- ⊗ coronarsklerosis
- ⊗ stress pain in your legs when walking less than 100 m
- ⊗ acute respiratory infections)
- ⊗ feverish infections
- ⊗ circulatory problems, feeling of dizziness
- ⊗ nausea, Vomiting
- ⊗ acute coronary syndrome
- ⊗ acute myocardial infarction
- ⊗ symptomatic severe aortic stenosis
- ⊗ decompensated cardiac insufficiency
- ⊗ acute pulmonary embolism
- ⊗ acute carditis (Myo-, Endo-, Pericarditis)
- ⊗ acute phlebothrombosis of the upper extremities
- ⊗ acute aortic dissection

If the following symptoms occur the training must immediately be stopped to avoid an overstress of the human organism!

- ⊗ distress respiratory, sense of oppression
- ⊗ angina pectoris (chestpain in sudden attacks)
- ⊗ maximum heart rate > 200-age
- ⊗ nausea, emesis
- ⊗ circulatory problems
- ⊗ illness (heavily tiredness, lassitude, feeling of dizziness)
- ⊗ rapidly decreasing heart rate
- ⊗ rapidly decreasing/increasing blood pressure
- ⊗ main artery disease
- ⊗ moderate cardiac valve diseases
- ⊗ electrolyte imbalance
- ⊗ arterial hypertension (RR > 200/110mmHg)
- ⊗ tachyarrhythmie oder Bradyarrhythmie
- ⊗ hypertrophic-obstructive cardiomyopathy and other forms of outflow tract obstruction
- ⊗ advanced AV-blockages
- ⊗ anemia
- ⊗ physical and/or mental health problems
- ⊗ arrhythmias

Chapter 3 Quick Reference

3 Quick Reference

After delivery of your cardio machine, please check if the serial number (see name plate) is identical with the one indicated on the delivery note and if all components listed in chapter 1.3 („Parts included in the delivery“) are included in the delivery.

After the machine has been plugged in and switched on, the software version is displayed. Then the main menu will appear.

The control panel provides the PLUS, MINUS, START, STOP and BP buttons in this order.

The liquid-crystal display (LCD) is illuminated and shows the elapsed training time (min:s), your heart rate and the oxygen saturation (SPO₂), the speed range (1/min) the power (Watt).

When starting the workout on the machine, the main menu will always appear first. Hold the PLUS or MINUS button until MANUAL is highlighted and confirm your selection with START. You are now in the manual mode.

In this mode you can select any workout time and choose any workload level. The workout parameters will be displayed.

Press STOP to stop your examination. The workout parameters remain on the display. Press the STOP button again to return to the main menu. The display will also automatically return to the main menu after 2 minutes if no action is carried out.

Please note!

For workouts in Profile mode also using the oxygen measurement please read the detailed instructions.

Chapter 4 Intended Use

4 Intended Use

The STRESS ECHO X MED is a multifunction table composed of an adjustable examination table and a pivoting ergometer. It can be used for non-invasive cardiac diagnostics as well as all conventional ultrasound examinations.

The table is designed for use in clinics, cardiologists' offices, or similar facilities.

The STRESS ECHO X MED offers a range of adjustment options in order to create suitable examination conditions even for seriously ill patients with positioning problems or after cardiac surgery interventions (bypass and the like).

The table top can be tilted and/or pivoted in 2 directions, allowing it to be used for all conventional ultrasound examinations. Continuous tilting and pivoting is performed via remote control by electric motors.

The ergometer can be raised and offers a special table for mechanical stress echocardiography. It operates with a fully electronic eddy current brake controlled by the software.

The control cockpit lets you select a manually adjustable level as well as 5 predefined profiles and one predefined, adjustable WHO profile.

By connecting peripheral ECG devices, ECG curves can be recorded to match the load levels. The load display at the patient's eye level allows them to control the cadence at all times. The pad which can be flipped down to the side allows for optimal positioning of the ultrasonic probe.

It is approved for persons with a height between 1.40 m and 2.0 m and a maximum body weight of 200 kg.

Notice! Not all ECG devices can be connected to the STRESS ECHO X MED.

A list of compatible external equipment can be obtained from ERGO-FIT, please phone +49 (6331) 2461-0!

Chapter 5 Transport and Installation

5.1	Transport	18
5.2	Setup Location and Installation	18
5.3	Ambient temperature	19
5.4	Plugging in	19
5.4.1	Power supply	20
5.4.2	Cabeling	21
5.5	Potential compensation	21

5 Transport and Installation

5.1 Transport

In order to avoid damage, ERGO-FIT machines are transported by ERGO-FIT GmbH & Co. KG directly or by an authorized freight forwarding company. After delivery, packaging will be collected and disposed by ERGO-FIT GmbH & Co. KG. If ERGO-FIT machines are delivered by a freight forwarder, the customer must dispose the packaging himself or may send it back to ERGO-FIT GmbH & Co. KG (transportation costs are on behalf of the customer).



The machines do not have any shipping locks!



Please observe the following in order to move the table to the desired position:

1. Stand at the foot of the device. The table may only be moved after the tilt angle of the table top has been moved to zero.
2. Release the foot-activated locks on both sides (Figure 1). Now you can easily roll the device to the position you want. Ensure that you don't pull on the pads during this process.
3. Push the table to the desired position. Adjust the table to the floor by turning the adjustable feet with an open-ended size 19 wrench. (Figure 2).
4. After adjusting the feet, push the foot-activated locks down to lock them (Figure 3). It may be necessary to repeat steps 2-4 in order to achieve optimal positioning of the table.



Adjusting and locking the table

5. If you need to raise the reclining area, make sure that it is attached to the metal frame below the pad.

5.2 Setup Location and Installation



- ⊗ Make sure that the surface underneath the machine is level and flat.
- ⊗ You must never remove small irregularities of the ground by laying wood, cardboard or similar materials. This leads to an increased risk of accidents. Minor unevenness can be compensated by means of the adjustable screw feet. Adjust the leveling screw feet until the machine stands safely. It is mandatory to adjust the levelling foot because it is the machine's support.

- ⊗ Please note that the adjustable feet at the foot of the table are cushioned with rubber plugs. On rare occasions rubber (e.g. in combination with aggressive cleaning agents) can leave marks and/or cause discoloration of the floor.
- ⊗ Set up the machine so that power switch and plug can easily be disconnected:
- ⊗ For safety reasons, please leave enough space around the machine for the user to move safely and to avoid that bystanders are hurt by moving parts: Seen from the access orientation, maintain a clearance of at least the training space plus 0,6 m. Provide enough space for an emergency disassembly. Adjacent machines may use the same clearance.
- ⊗ Don't place the device in the immediate vicinity of devices with a high level of electromagnetic radiation.

5.3 Ambient temperature

- ⊗ The exercise machine must not be used outdoors.
- ⊗ Your ERGO-FIT exercise machine may be used at an ambient temperature of +5°C to +40°C, a relative humidity of 10% to 80% (non-condensing) and an atmospheric pressure of 700 hPa to 1060 hPa without causing any problems. Operating height below 2000 m.
- ⊗ When switched off, the ERGO-FIT machine may be stored at a temperature between -5° to +40° and a relative humidity of 10% to 80% (non-condensing).
- ⊗ If a blood pressure module is installed, it will withstand a temperature range of +10°C to -40°C, a relative humidity of 15% to 85% and an air pressure of 970 hPa 1,050 hPa in the off and on state.

5.4 Plugging in

1. Perform a visual inspection of the power cord and the input connector (power entry module) before using the machine. Damaged power cords and connectors need to be replaced immediately.
2. Plug the power cord into the provided mains input module. The plug clicks into place automatically. Plug the other end of the cable into the outlet. .



3. Turn your device on using the mains switch. It is located on the frame at the foot of the table. After your exercise machine has been connected to mains and switched on, it automatically carries out an operating check. During this operating check, you will be able to read the software version of the unit on the display. Thereafter the main menu will appear
4. Check if the display works. If this is not the case, make sure you followed the steps above correctly. In addition, verify if there is electricity in the mains socket.

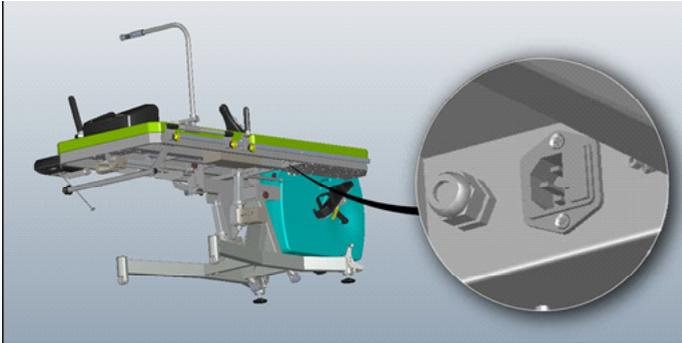

Power Connection

The training bike and the adjustment device control are connected separately. Thus, the adjustment device operates independent from the training bike.

5.4.1 Power supply

Use your exercise machine only with earthed (grounded) power sockets with 230 VAC / 50-60 Hz (see chapter A5). If you have any doubts about the power supply at the setup location, ask your energy provider. Only use commercial 10 ampere automatic circuit breakers (type B tripping characteristic). In the rare event that these automatic circuit breakers should switch off when you switch on your machine, the circuit needs to be fused with 10 A lead fuses or with a different type of tripping fuse (e.g. K-automat). In case of doubt, ask your electrician.



Before connecting your ERGO-FIT exercise machine to your power supply system compare the acceptable voltage and frequency on the name plate (next to power entry module) with your local data.

Always connect your machine directly to the power outlet. If its possible do not use extension cables or multioutlet power strips unless they are EN 60601-1 certified.

The motor controller outlet is intended solely for connection of the motor controller and must not be used for other devices, device components, or accessories.

We recommend DC-isolated cables for the connection of external equipment to the STRESS ECHO X MED.

5.4.2 Cabeling

- ⊗ Make sure that nobody can step on or stumble across the power cord.
- ⊗ Do not place any objects on the cord as it might get damaged.
- ⊗ When transporting the table or changing its position, place all cables on top of the table.
- ⊗ Set up the machine so that power switch and plug can easily be disconnected

5.5 Potential compensation

To avoid faults or in order to protect against contact voltages between touchable conductive parts of the multifunction table and other devices in the patient environment, the multifunction table should be connected to the clinic's internal potential equalization system via a potential equalization cable. By default, the bed is equipped for potential equalization. The grounding bolt is located beneath the control panel.

Never connect the potential compensation line to the water or gas supply line or any other kind of pipe. Always use the appropriate potential compensation connection only.

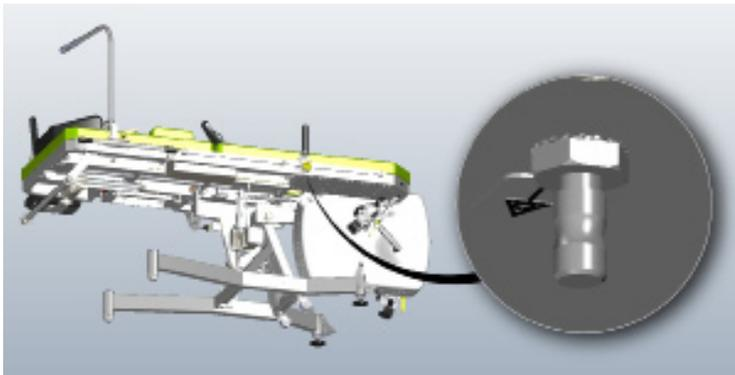

Chapter 6 Setup

6.1	Switching On	24
6.2	Switching Off	24
6.3	Components	24
6.3.1	Ergometer	26
6.3.2	Manual switch	26
6.3.3	Right handle	28
6.3.4	Seat	28
6.3.5	Load display	28
6.3.6	Head/shoulder support	29
6.3.7	Left handle	29
6.3.8	Folding pad	30
6.3.9	Paper roll holder	30
6.3.10	Hip support	30
6.3.11	Foot activated locks	31
6.3.12	Power connection	31
6.3.13	Power switch	31
6.3.14	The control panel	31
6.3.14.1	The buttons	33
6.3.14.2	The display	33
6.3.14.3	Connections	33
6.4	Blood pressure module.....	35
6.4.1	Connectors and buttons on the blood pressure module.....	35
6.4.2	Attaching the blood pressure module.....	36

6 Setup

6.1 Switching On

- ⊗ Before switching on your exercise machine, make sure the machine is plugged in.



If you have connected several ERGO-FIT machines to one circuit never switch on multiple machines at the same time. Otherwise technical problems might occur.

- ⊗ Now turn the device on by activating the mains switch on the frame at the foot of the device. The switch must be in position I. If the switch is in position O the machine is switched off
- ⊗ The illumination of the display shows you immediately if the machine is switched on.

6.2 Switching Of

- ⊗ Switch off your machine by pressing the power switch. The switch must be in position O.



Take care that the switch-on and switch-off intervals don't fall below a time of 30 sec. Otherwise faults may occur.

6.3 Components

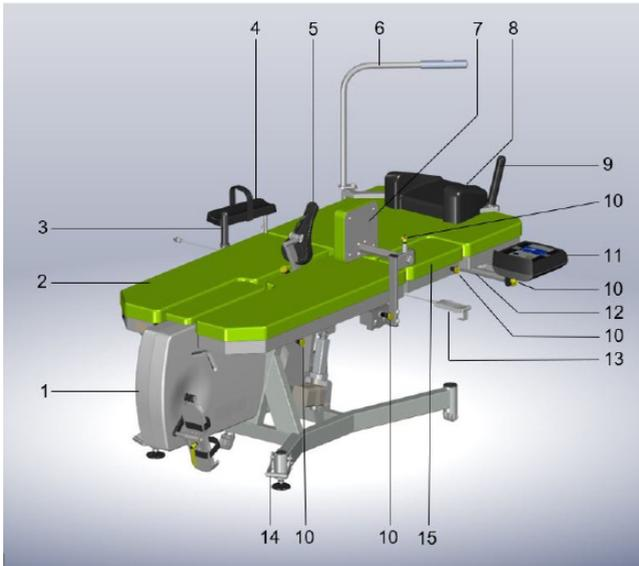

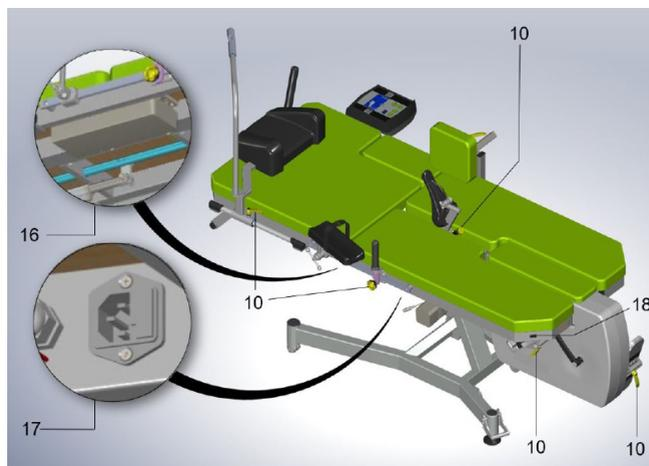

- 1 Ergometer
- 2 Table Top
- 3 Right handle (stabilizes the lateral position)
- 4 Armrest
- 5 Seat
- 6 Load display (patient speed/ power output range)
- 7 Hip support
- 8 Head and shoulder support
- 9 Left handle (supports examination)
- 10 Control elements, such as locking pins, clamping levers (all yellow)
- 11 Control panel
- 12 Paper roll holder
- 13 Manual switch for operation of the positioning motors
- 14 Foot-activated locks
- 15 Folding pad
- 16 Controlling the adjustment devices
- 17 Power connection
- 18 Power switch

6.3.1 Ergometer

The ergometer on the table is adjustable and can be raised or lowered. In this manner, the STRESS ECHO X MED can also be used as an examination table.

The ergometer can be adjusted with a locking pin, activated by a handle (mushroom button) on the right at the foot of the table. The ergometer is moved into the training position by pulling briefly on the handle and moving the ergometer up at the same time until it clicks into place.

Pull briefly on the handle again to fold the ergometer down. The ergometer is moved down largely on its own by a gas strut. Ensure that the pedals are not in the way. Engage the ergometer in its final position by applying slight pressure.

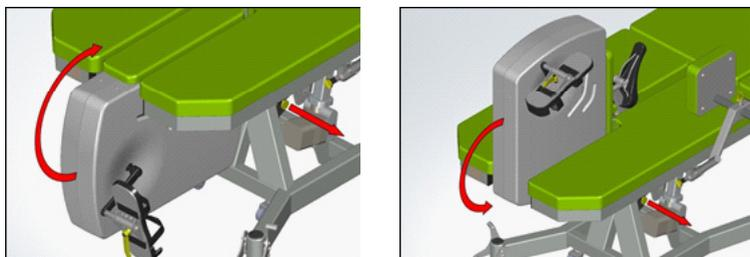

6.3.2 Manual switch

The table top can be adjusted via electric motors and two axes in both the longitudinal and transverse directions (respectively by 45°). The manual switch is used to execute one or more tilting movements.



Please proceed as follows:

- ⊗ Ensure that the tilting mechanism is only used with the hip support in place in order to avoid damage to health .
- ⊗ The table may only be tilted with the adjustable feet locked, in order to prevent instability and collision of the table top with the adjustable feet levers
- ⊗ Ensure a sufficient safety clearance before using the tilting mechanism.

An area with two pushbuttons is located on the front panel of the manual switch for each movement. The symbols indicate the function of the individual keys. The drives are operated as long as the keys are held.

In addition, three additional individual table settings can be programmed and assigned to the P1-P3 keys.

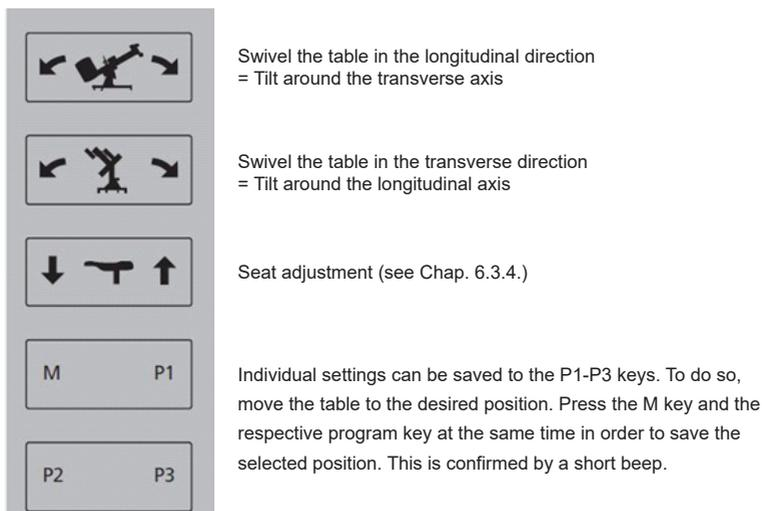

In order to recall the desired setting, press and hold the desired key. Then the table moves to the corresponding position .

Function with lowered ergometer:

- ⊗ If the ergometer is lowered, the table top can be tilted by up to 45° around the longitudinal axis.
- ⊗ The table can easily be converted to a normal examination table if the ergometer is lowered. The seat must be removed to do so, see section 7.1.4 „Seat“. The head/shoulder support can also be flipped up if necessary, see section 7.1.6 „Head and shoulder support“.

After the training bike has been folded down the lateral axis will be locked and cannot be tilted anymore. It is even locked when operated via the remote control.



Function with the ergometer folded up:

- ⊗ With the ergometer folded up, the table top can be tilted by up to 45° around the transverse axis. Tilting around the longitudinal axis is locked out at this time.
- ⊗ Combined tilting around the transverse and longitudinal axes is possible: 30° around the transverse axis and 45° around the longitudinal axis.
- ⊗ Adjusting the tilt around the longitudinal axis is locked out automatically as soon as the tilt angle about the transverse axis exceeds 30°.
- ⊗ The tilting adjustment about the transverse axis is automatically limited to 30° if the longitudinal axis is already inclined at an angle of more than 3°.

User programmable functions:

- ⊗ The user programmable functions are only available with the ergometer folded up.

6.3.3 Right handle

The handle position can be adjusted horizontally on the standard rail. It provides additional stabilization of the patient during sideways tilting.

6.3.4 Seat

The seat can be positioned easily via a locking mechanism, with a slight rotation it will be get more easy.

The seat is removed by pulling briefly on the mushroom button and turning the seat out of its holder at the same time.

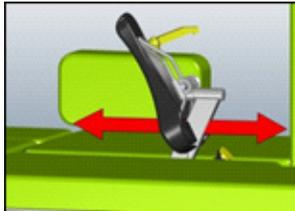
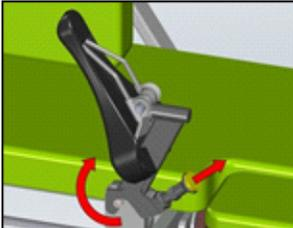

A positioning motor controlled with the manual switch is used to adjust the horizontal position. The supporting pad is automatically adjusted as well. Please note: In order to avoid injuries, talk to the patient before adjusting the seat and maintain eye contact with the patient while adjusting the seat.



6.3.5 Load display

The display is mounted on a pivoting bracket. This allows it to be swiveled so that the patient can see it.

The icons used on the display (Up and Down arrow) provide feedback to the patients so they know if they have to increase or decrease the pedal frequency:

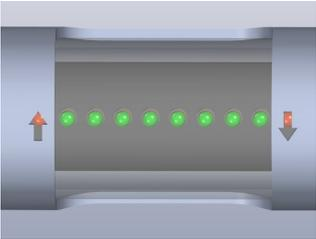

- ⊗ Orange light left/Up arrow: Pedal frequency too low
- ⊗ Orange light right/Down arrow: Pedal frequency too high
- ⊗ Green lights: Pedal frequency OK

6.3.6 Head and shoulder support

The head and shoulder support is intended to stabilize the patient on the table. The pads provide a high level of comfort.

The support can be adjusted linearly in the horizontal direction in order to adjust it to the patient's size by loosening the clamping lever. To move the head and shoulder support, lift it slightly. This prevents damage to the table top. Once the support is in the desired position, re-tighten the clamping lever to secure it.

If you don't need the head and shoulder support or while applying sanitary paper, simply swivel the support up and away from the table top. The bracket with load display is swiveled away at this time.

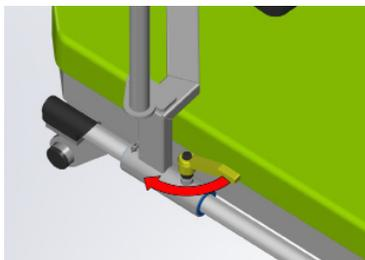

Loosening the clamping lever

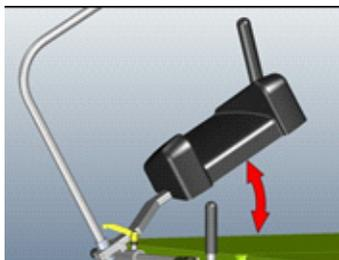

move the head and shoulder support

Ensure that the support is folded up over the full swiveling range. Ensure that there is sufficient clear space beside the table for this purpose. The table may only be operated with the support folded up if the support is folded up completely - past 100°. Otherwise there is a risk of patient injury since the head and shoulder support may flip back down .



6.3.7 Left handle

The handle above the head and shoulder support makes it easier to assume the position for examination with the ultrasonic probe.

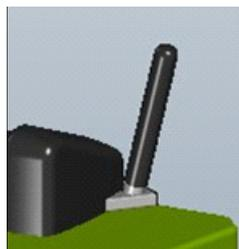

6.3.8 Folding pad

Folding the pad down creates an opening in the table top which allows for unrestricted examination with the ultrasonic probe.

Pull the mushroom button on the pad to fold it down. This folds the pad down.

If you don't need the head and shoulder support or while applying sanitary paper, simply swivel the support up and away from the table top. The bracket with load display is swiveled away at this time. To restore the full table top, pull the pad up by the handle until it clicks into place.

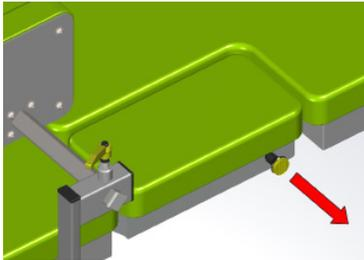

Pull the mushroom button

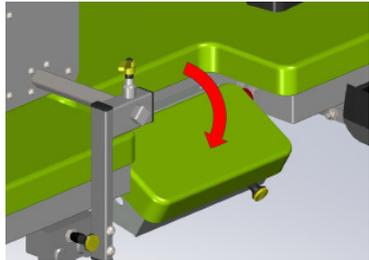

Fold the pad down

6.3.9 Paper roll holder

For hygienic reasons, it is possible to protect the table top with a paper underlay. A paper roll holder is located under the head of the table top for this purpose. In order to be able to pull the sanitary paper over the table top, loosen the clamping lever on the head and shoulder support, raise it, and pull the sanitary paper through underneath and over the table top. Then re-tighten the clamping lever.

6.3.10 Hip support

The hip support can be adjusted horizontally.

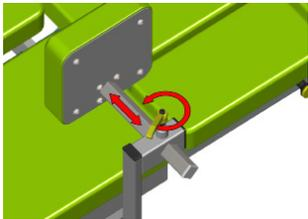

For horizontal adjustment to the patient in the transverse direction, loosen the clamping lever.

Adjust the hip support manually. After adjusting the support, re-tighten the clamping lever .

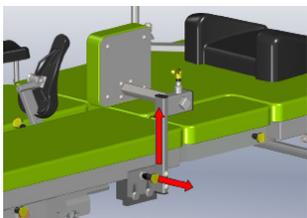

To remove the hip support, pull on the trigger (mushroom button) and pull the hip support out.

To install the hip support, slide it into the holder until it clicks into place.

In order to avoid injuries, talk to the patient before adjusting the hip support and maintain eye contact with the patient while adjusting the hip support.

6.3.11 Foot-activated locks

See Chapter 5.1 „Setup“.

6.3.12 Power connection

See Chapter 5.4 „Plugging in“.



6.3.13 Power switch



The mains switch is located on the frame at the left side at the foot of the table.

To turn the table on, toggle the switch to the I position.

To turn the table off, toggle the switch to the 0 position.

6.3.14 The Control Panel

ERGO-FIT exercise equipment is known for its outstanding ease of use. The STRESS ECHO X MED is equipped with a user guidance system that is simple and easy to understand.

On the control panel you find a display and several buttons. Before you take a closer look at the control panel please consider the following aspects:

1. Do not lean on the control panel or the display. It may get damaged.
2. Do not exert pressure on the display.
3. Only press the buttons lightly. When you press a button you will hear a beep.

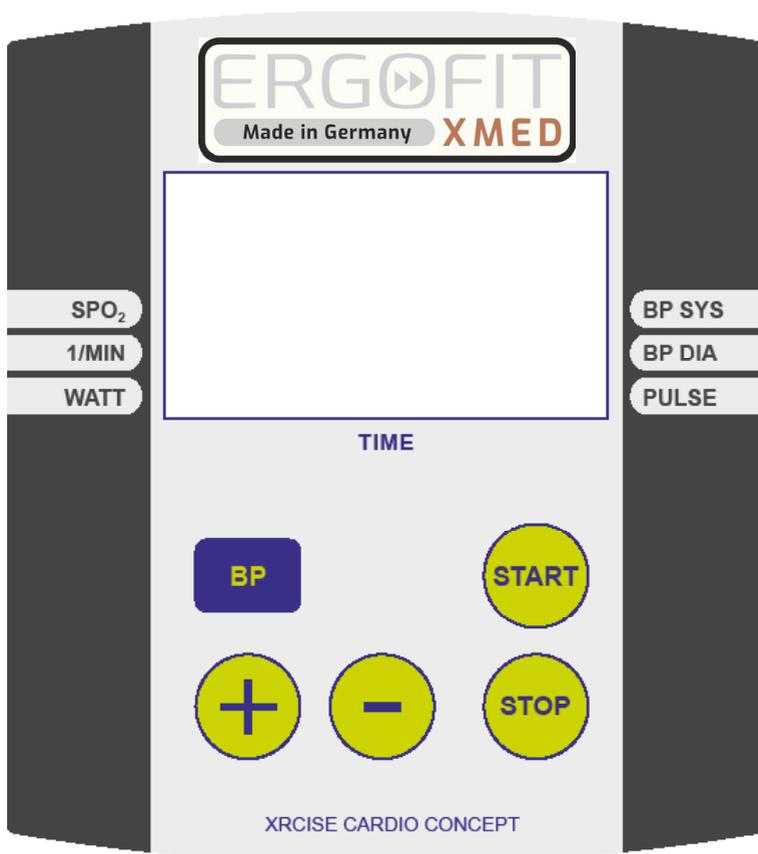

6.3.14.1 The Buttons

Depending on the model you will find the following buttons on the control panel:

PLUS: With this button you can increase the intensity or change parameters.

MINUS: With this button you can decrease the intensity or change parameters.

START: With this button you can confirm workout mode selections or parameter settings.

STOP: With this button you can cancel a function or stop the machine.

BP: Starting the bloodpressure measurement

6.3.14.2 The Display

The STRESS ECHO X MED is equipped with an LCD-display that consists of an monochrome graphic display. In the section below you will find model-specific information on displays, measuring units and their meanings.

Display	Explantation	Unit
SPO ₂	Oxygen saturation	%
1/MIN	Rounds per minute	rpm
WATT	Current performance	Watt
TIME	Workout time	00:00 (min:sek)
BP SYS	Systolic blood pressure value	mmHg
BP DIA	Diastolic blood pressure value	mmHg
PULSE	Current heart rate per minute	1/min

6.3.14.3 Connections

At the back of the control panel of any STRESS ECHO X MED machine you can connect devices to measure the blood pressure or the oxygen saturation (optional). Moreover you will find a USB port.

SPO₂

Connect the 9-pin cable to the corresponding connector. To disconnect just pull the plug from the connector.

Please note: For the SPO₂ module only use finger clips that have been accepted by the manufacturer. You can order them at ERGO-FIT.

Blood pressure

Connect the cable (power inlet) for blood pressure measurement at the specified location. When disconnecting the cable consider the following: Loosen the power inlet by pressing the small black button on the connector head before removing the cable.

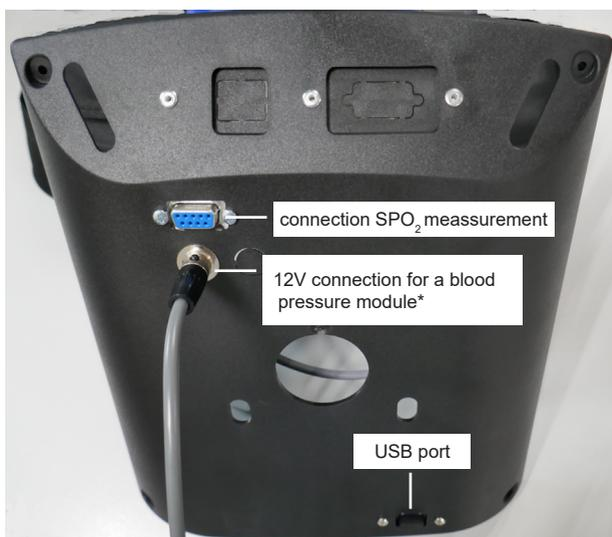
**USB**

The USB port is needed to update the device software. Format any USB sticks that you want to use for updating the software in order to avoid damages to the operating system.

Please review the additional safety and operational instructions in this manual!

6.4 Blood pressure module

6.4.1 Connectors and buttons on the blood pressure module

Air pressure port

Insert the air pressure port of the blood pressure cuff at the specified position. When removing, please pull the grooved ring.

Microphone connector

Insert the microphone connector of the blood pressure cuff at the specified position.

Power Inlet

Connect the cable (power inlet, connects the cockpit with the blood pressure module) to ensure power supply at the specified location. When disconnecting the cable consider the following: Loosen the power inlet by pressing the small black button on the connector head before removing the cable.

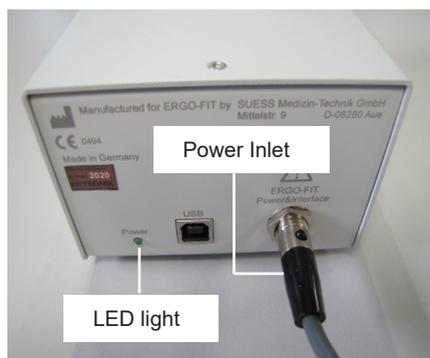
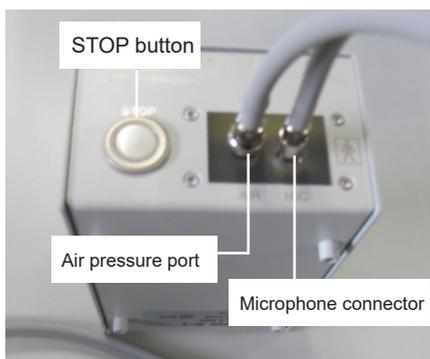

STOP button

By pressing the STOP button during a measurement procedure, the blood pressure measurement can be aborted and stopped immediately. The system deflates, and the machine returns to the Ready state.

If you press the STOP button while the machine is in the idle state, i.e. when no measuring is performed, the system will be reset. A reset resets the basic state of the BL-6 device and sets the MEASUREMENT PROFILE to NORMAL.

LED light:

The LED light indicates whether the blood pressure module is receiving power. When the LED light is on, it means that the power supply is enabled.

6.4.2 Attaching the blood pressure module

The holes in the retaining plate have openings that allow the blood pressure module to be installed vertically or horizontally in the sockets. (See the next figure)

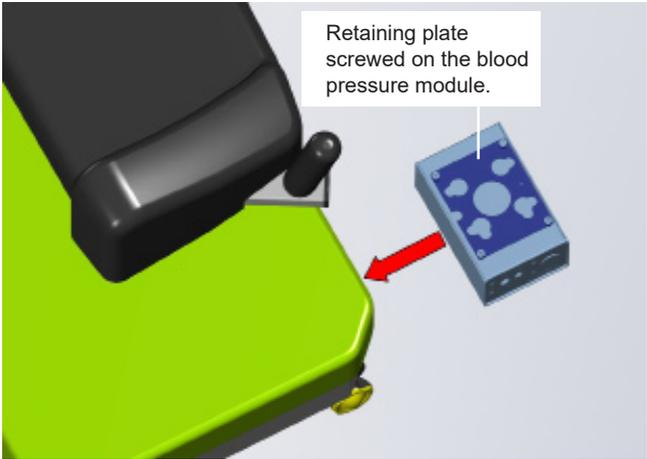

Place the blood pressure module under the blood pressure module holder and slide the holes of the mounting plate over the sockets of the blood pressure module holder, press lightly on the blood pressure module holder and push in the direction of the arrow until it snaps into place.

Important: Stop button points in the direction of the cockpit.

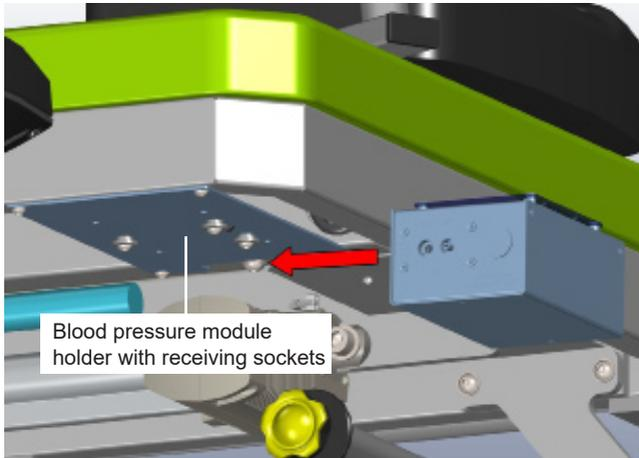

Chapter 7 Operation

7.1	Operation Modes	40
7.1.1	MANUAL	40
7.1.2	PROFILES	41
7.1.3	WHO-PROFILES	43
7.1.4	External Connection	44
7.2	Device-Specific Behavior after the Workout	45
7.3	Funcional Test	45
7.4	Default settings	46
7.5	Blood pressure measurement.....	47
7.5.1	Cuff sizes.....	47
7.5.2	Using the cuff.....	48
7.5.3	Measuring Method.....	50
7.5.4	Measuring Process.....	54
7.6	SPO ₂ measurement	53

7 Operation

7.1 Operation Modes

When you power on the device the first thing you see is the main menu with the following options:

- ⊗ MANUAL
- ⊗ PROFILES
- ⊗ WHO-PROFILES

To return to the main menu press the STOP button once or several times.



Note! Pacemaker patients are recommended to only use the MANUAL mode!

7.1.1 MANUAL

In this mode you can choose any workout time and workload.

1. Press PLUS/MINUS until MANUAL is highlighted. Confirm your selection with START.
2. You now access the workout mode. Here you can change the workload by pressing PLUS/MINUS. If you want to change the workload substantially, press and hold PLUS/MINUS. On the TRAC you can also change the incline by pressing UP and DOWN.
3. top the workout by pressing the STOP button. The workout parameters (Watt, 1/min etc.) remain on the display and are visually demonstrated in the workout profile. By pressing STOP again you return to the main menu.

In MANUAL mode you select any minimum/maximum workload. The workload limits are as follows (depending on the device):

Power Range	Increments	Speed
15 ¹ - 600 W	5 W	20 - 120 rpm

* 1: Presetting = 25W; can be reduced to 15W by pressing the MINUS button.



Please note that the resistance range below 25 W is not defined in the DIN VDE 750-238 standard!

7.1.2 PROFILES

Choose from five different predefined profiles (60 minutes). The profiles provide different workload sequences, comparable with a hilly landscapes. The five predefined profiles (1 - 5) are:

Profile 1:

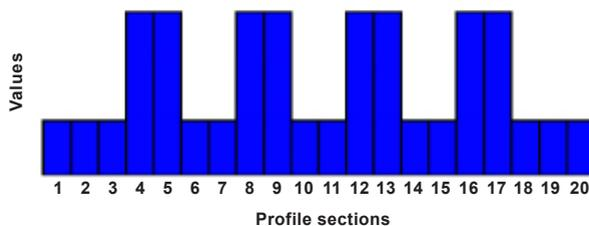

Profile 2:

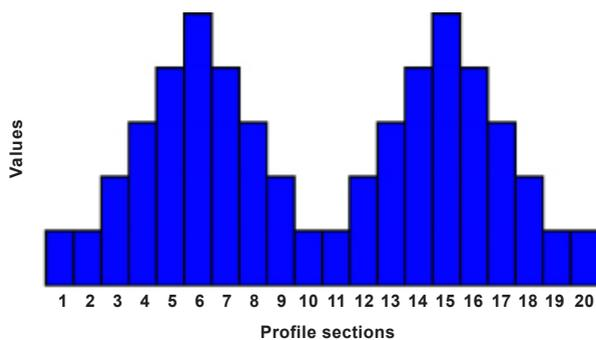

Profile 3:

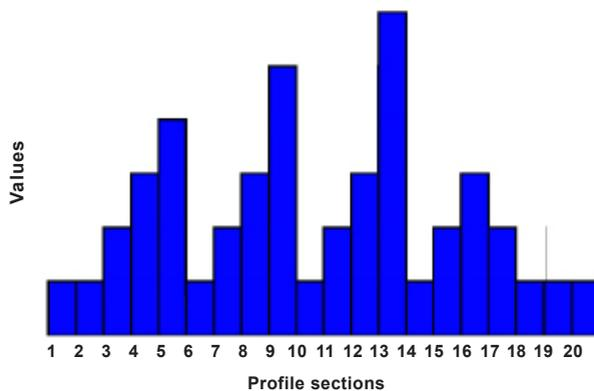

Profile 4:

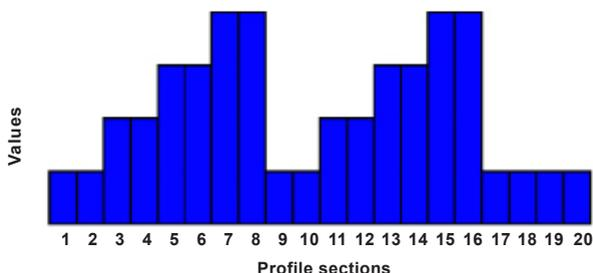

Profile 5:

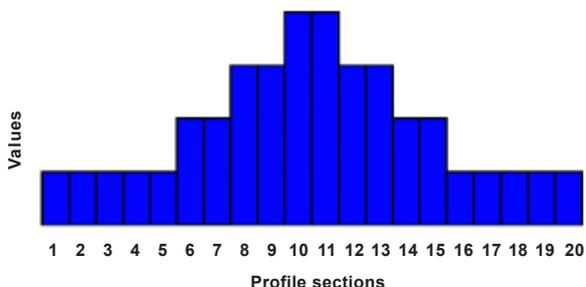

Please proceed as follows:

1. Press PLUS/MINUS until PROFILES is highlighted. Confirm your selection with START.
2. The PROFILE submenu is displayed. Select a profile by pressing PLUS/MINUS. Confirm your selection with the START button
3. Now you have to enter the minimum/maximum workload. Press PLUS/MINUS to change the values. If you change the minimum value the system changes the maximum value accordingly. Confirm the workload values with START.
4. Define the maximum operating time. You can select different working times between 10 to 60 minutes (default time 20 minutes) by pressing PLUS/MINUS. Confirm your selection by pressing START.
5. You now access the workout mode. Here you can change the workload by pressing PLUS/MINUS. You can only use values within the previously defined workload range.
6. The workout will stop automatically after the defined workout time has elapsed. You can also stop the training at any moment by pressing the STOP button. In either case the workout parameters (Watt, 1/min etc.) remain on the display and are visually demonstrated in the workout profile. By pressing STOP again you return to the main menu

7.1.3 WHO-PROFILES

The WHO profiles are step profiles defined by the World Health Organization (profiles with stepping strain increase).

WHO-Profile: stepping strain increase (step profile)

Initial strain:	Strain of the first strain level [W]
Time:	Duration of each strain step [min]
Strain step:	Intensity of each strain step [W]
Recovery:	Strain in recovery phase [W]

Please proceed as follows:

1. Push the PLUS/MINUS buttons until the programme WHO-PROFILES is selected. Confirm your choice with the START button.
2. You are now in the WHO PROFILE mode where you can see the settings. Press the START button to start with the WHO PROFILE with preset settings for Time, Load etc. ACTIVE will be shown on the display.
3. If you want to change the settings, select the settings in the WHO PROFILE mode by pressing the STOP button. Then change them by pressing the PLUS/MINUS buttons. Press the STOP button again to activate the WHO PROFILE.
4. Press the STOP button to stop the strain phase and to proceed to the recovery phase (PASSIVE).
5. By pushing the STOP-button one more time, you will return to the main menu.

The automatic strain increase in the preset as well as in the individual WHO profiles can be interrupted during operation by pressing the START button. The displayed information changes from ACTIVE to HOLD. In the HOLD mode, the performance can be modified manually with the PLUS and MINUS buttons. If you want to reactivate the automatic strain increase, press the START button again. The display changes from HOLD to ACTIVE. In both modes, you can change from the strain phase to the recovery phase by pressing the STOP button. The display changes to PASSIVE. This allows the doctor to adjust the strain for his patient more precisely than before.

7.1.4 External Connection

A serial interface (RS232) is standard equipment on the STRESS ECHO X MED.



Please note! Some ECG devices cannot be connected with the STRESS ECHO X MED. Call +49 (6331) 2461-0 for more information.

Control of the ergometer by external devices:

For control by external devices (ECG, PC, etc.), the corresponding data protocol must be selected first. The data protocol is set by the installer. If the initialisation is received through the interface, the STRESS ECHO X MED automatically changes to the operating mode „external control“ („ECG no.“ and the protocol number will be shown in the middle of the display). It is not necessary to select the menu item. In addition, the recognised control characters will be displayed for checking purposes. Unknown commands will be shown as „ / ..“. Printing is not supported during external control.

If disturbances occur between the ECG device and the bike ergometer, potential compensation can be installed (see Chapter 5.4).

Data protocols:

Use the interface cable to connect the STRESS ECHO X MED with the external device (ECG, PC etc.). Then the correct data protocol needs to be set:

1. You are in the main menu. Access the service menu by pressing the PLUS and MINUS keys at the same time. Select the „RS232 Interface“ function.
3. Use the PLUS/MINUS keys to select the desired protocol (00, 01, 02,...) and confirm your selection with the START key. The protocol selection is saved for further use. Use the STOP key to return to the main menu at any time.

If the initialisation is received through the interface, the STRESS ECHO X MED automatically changes to the operating mode „external control“. In addition, the recognised control characters will be displayed for checking purposes. Unknown commands will be shown as „ / ..“. Printing is not supported during external control.

7.2 Device-Specific Behavior after the Workout

You do not need to observe any special instructions at the end of the workout. Just stop the workout. There is no increased risk due to coasting.

7.3 Functional Test

For a functional test please proceed as follows:

Brakes

- ⊗ Switch on the device. The display lights up as soon as the machine is ready.
- ⊗ Select MANUAL mode and increase the power range (see Chapter 7.1.1).
- ⊗ Move the pedals at the lowest speed (see the arrows!). The resistance increases. Increase the speed range to its maximum. The resistance decreases. If this is the case the rpm-independent operation works fine.

Related Functions

- ⊗ Make sure that the seat can be adjusted easily.
- ⊗ Make sure that the Head support can be adjusted easily.
- ⊗ Make sure that the Hip support can be adjusted easily.

7.4 Default Settings

For changing the default settings, you can use the following buttons:

PLUS:	You can navigate in the menu and increase settings
MINUS:	You can navigate in the menu and decrease settings
START:	You can confirm your selections or settings!
STOP:	You can cancel a function or leave the menu

Language settings:

In the main menu simultaneously press PLUS and MINUS to open the "Service" menu. Select the function "Language". Here you can change the language.

Date and Time settings:

In the main menu simultaneously press PLUS and MINUS to open the "Service" menu. Select "Time and Date". Here you can change the settings.

7.5 Blood pressure measurement

STRESS ECHO X MED can be used to carry out auscultatory measurements of the blood pressure values. This type of blood pressure measurement is only possible during ongoing operation of a training mode (e.g., in manual training).

Make sure that the blood pressure module is correctly connected to the machine, that the cable and air hose are secured (see Chapters 6.3.14.3 and 7.6.2), and that it is securely mounted in the provided base (see Chapter 6.4.2.). Select a cuff size adapted to the upper arm (see the table below). The cuff must be completely deflated before it is placed on the arm. Measure the blood pressure quietly over the clothes! Under no circumstances should a shirt, blouse or sweater sleeves be pushed up or wrapped up, as this can hinder blood flow and lead to incorrect measurement results. The blood pressure cuff can always be placed over the sleeves of shirts, blouses, or thin sweaters. This does not affect the accuracy of the measurement results. Please note that the clothing directly under the microphone is tight and has no wrinkles. Measuring the blood pressure over clothing saves time and protects the cuff. When placing the cuff on the arm, pay attention to the location of the microphone and make sure that the cuff fits well. It is preferable to measure the blood pressure on the right side, since this is where the armrest is attached.

7.5.1 Cuff sizes

Type	Upper arm circumference	Implementation
Adult	29 cm - 40 cm	D-ring cuff
Small Adult	25 cm - 31 cm	D-ring cuff
Large Adult	up to 56 cm	Velcro cuff

7.5.2 Using the cuff

Position the microphone on the inside of the upper arm between m.Biceps and m.Triceps. The microphone must be clean. The elbow must be completely free, and there should be a two-finger distance between the elbow and the cuff:



Important: The microphone must be clean.

The cuff is infinitely adjustable to fit almost all shape of upper arms - from cylindrical to conical. Adjustment for conical upper arms is done by adjusting the angle of the bracket in the cuff using the „adjustable cone“ rear strap. There should always be a finger-wide distance up top and at the bottom:

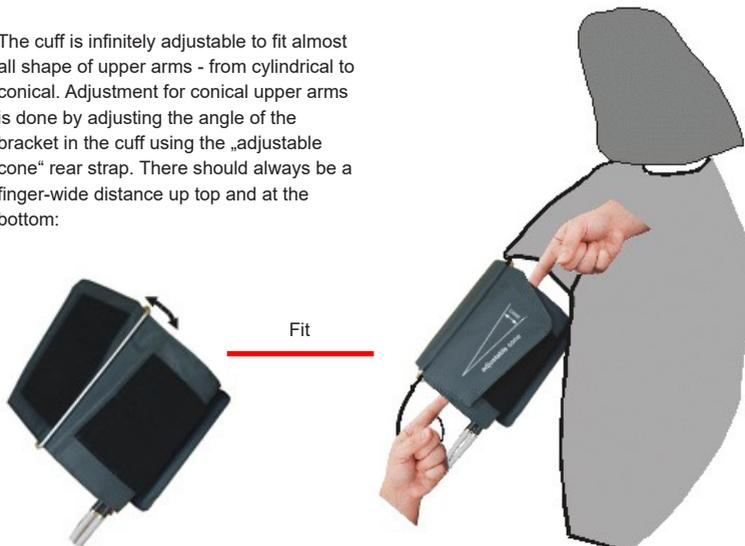

Please note:

- ⊗ The blood pressure cuff must be free and must not be in contact with the machine during the measurement procedure
- ⊗ The blood pressure cuff tubes must be secured to the forearm and the machine to prevent pendulum or swinging motions. Please use the attached tie-down loops for this purpose.
- ⊗ The tube output of the cuff may not bend.
- ⊗ For persons who are particularly muscular in the upper arm, the position of the microphone must be pulled slightly to the side of the biceps in order to obtain a perfect measurement.
- ⊗ Measurement results should only be interpreted by medical personnel with appropriate training.
- ⊗ Single measurement results must never be used as a diagnostic tool to initiate treatment.
- ⊗ The cuff pressure should not exceed 300 mmHg, a safety mechanism will make the system deflate as soon as pressure greater than 330 mmHg is detected.
- ⊗ The patient can be relieved at any time after excessive pressure was applied by pressing the STOP button, pulling off the cuff tube or opening the cuff.
- ⊗ The measuring time should not exceed 2 minutes.
- ⊗ Blood pressure can be measured again under rest conditions after a recovery time of at least 2-5 minutes.
- ⊗ Make sure that the machine is not affected by unnecessary shock or vibrations.
- ⊗ Do not expose the machine to excessive dirt and moisture.
- ⊗ Be careful not to damage rubber parts with sharp objects.
- ⊗ The blood pressure cuff must be cleaned before it is used on another patient.

In the following figure, the sleeve tube secured by cable clips is indicated by the circle.

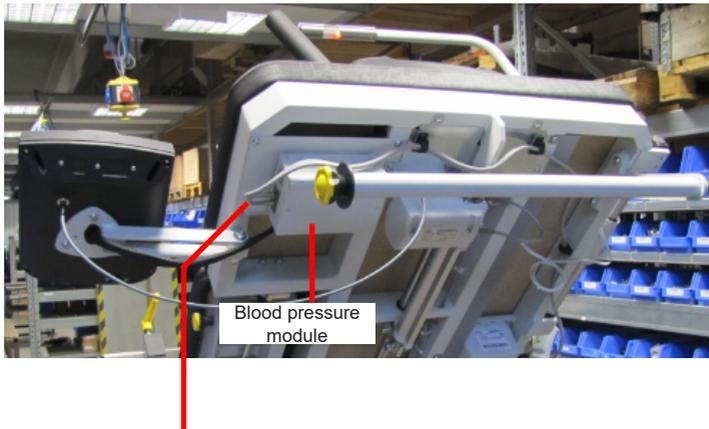

When installing the blood pressure cuff tube, make sure that it is not twisted or pinched in the connection area.

7.5.3 Measuring Method

The METRONIK BL-6 works according to the auscultatory measurement method (RR method) with an upper-arm cuff where a microphone is built in. The Riva-Rocci Korotkoff RR method is the gold standard for noninvasive blood pressure measurement. As a result, METRONIK sphygmomanometers measure extremely accurately and robustly, as in the case of stethoscope measurement.

The METRONIK BL-6, designed for ERGO-FIT, is specifically adapted for use in ergometry and works by default according to a practice-proven method, referred to as ERGO measurement profile in this document.

In this measurement profile, the sensitivity of the microphone amplifier is muted during the active phase.

In the event of an impact during ergometric examinations, the shape of the pulse wave - and thus the frequency components of the Korotkoff tones - change. As a result, pulse wave noises are audible even under diastolic pressure during exercise. Noise and motion are also sharply increased. In order to minimize these issues, the ERGO filter is switched on after the second measurement following a reset. It is an analog filter developed for optimum filtering of Korotkoff noise under Ergo conditions. As a result, automatic measurement results are much more reliable.

Please note the following.

Due to the strong filter component, the useful signal can also be trimmed during rest measurements with an activated ERGO filter. A sleep measurement with an activated ERGO filter can result in incorrect readings.

The Korotkoff sounds detected by the module are acoustically displayed by a digital signal generator. The module signals that the measurement is in progress.

Additional digital beeps may also be caused by environmental noise (such as cuff tube motions). This may invalidate the blood pressure measurement results. This can be avoided by securing the tube (see Chapter 7.6.2) and creating an optimal, quiet measuring environment. By monitoring these sounds during the measurement, the user can become assured with each measurement that the Korotkoff sounds have occurred simultaneously with the blood pressure and that the automatic measurement works comprehensibly and correctly.

The default ergometry filter (from the third measurement) attenuates the noise and pulse wave noise that occur during exercise. The built-in pressure chamber compensates for mechanical motion during ergometry.

The blood pressure cuff is to be understood as a single-tube system, although it is made with double tubes. One tube is used to inflate and deflate the air, and the other one connects the microphone cable. The microphone is integrated in the cuff bladder (also called the „soul“) for optimal low-interference and robust measurements. There are two robust connectors at the tube end of the blood pressure cuff that ensure quick and easy connection with the blood pressure monitor BL-6.

ERGO measuring profile:

ERGO measuring profile means that the ERGO filter is automatically switched on during active testing.

Measuring profile setting - recommended for active testing:

Start of an active test:

- | | |
|---|--------------------------|
| 1. Blood pressure measurement: Rest measurement | Normal measuring profile |
| 2. Blood pressure measurement: Pressure start | Normal measuring profile |
| From the 3rd measurement (the body is under pressure) | ERGO measuring profile |
| Each additional pressure measurement | ERGO measuring profile |

After 3:30 (min:sec) Measurement break switches BL-6 back.

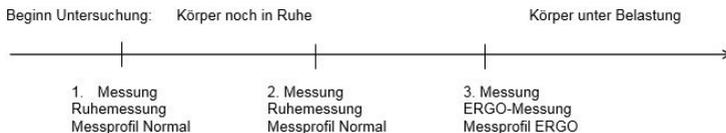

The sequence is reset either after the preset time for inactivity (downtime) or by pressing the STOP key.

Number of leading rest measurements (factory setting 2), downtime for resetting (factory setting 3 min 20 s), acoustic signal reproduction and other measuring profile parameters can be changed or adjusted individually using the BPControl service program. For more information regarding BPControl, please contact Ergo-Fit Customer Service. You can find the necessary contact details in Chapter A.1.

7.5.4 Measuring Process

Press the BP button on the control panel of the machine. The blood pressure cuff will inflate, and the measurement process will start. Measurement control is now indicated by the display of the current cuff pressure on the control panel. An acoustic feedback takes place after switching to the measuring mode. The current cuff pressure is displayed cyclically in the „BP SYS“ display field after the cuff starts inflating and until the end of the measurement process. In addition, the detected heartbeat is played back (acoustically) in the module. Keep your arm as steady and straight as possible during the measurement process.

After a short period of time, the display will show systolic (50 to 250 mmHg) and diastolic (20 to 150 mmHg) values, as well as the heart rate (40 to 200 BPM). These values will be displayed until the next measurement starts.

Please note:

- ⊗ Maximum deviation of blood pressure values: +/- 3 mmHG from 0 to 300 mmHg).
- ⊗ Measurement results on the left and right arm may vary.
- ⊗ If you attach the blood pressure cuff for a longer period, check the circulation of the respective limb.

7.6 SPO₂ measurement

With the STRESS ECHO X MED devices you can also measure the oxygen saturation (SPO₂). This is only possible during workout (e.g. manual workout).

The SPO₂ module must be correctly connected to the machine (see chapter 6.3.14.3. Connections). Attach the finger clip to forefinger, thumb or little finger. If measurement is needed attach the clip to the big toe.



The patient's skin on the finger must be dry and clean. Open the clip and put the finger as far as possible into the opening. Release the clip to lock it. Guide the cable along the arm and fasten it with tape, if necessary. Now you can perform the measurement. Do not move the hand during the measurement.

The measurement will now be performed automatically and permanently. The display shows the measurement values (70% to 100%) as well as the heart rate (20 to 300 bpm in whole beats (1 bpm)). These values will be displayed until you remove the finger clip or disconnect the SPO₂ module.

Please note:

- ⊗ With an oxygen saturation between 70% and 100% the maximum deviation of the measurement values is 2,3%.
- ⊗ The maximum heart rate deviation is +/- 3bpm.

Please review the additional safety and operational instructions in this manual!

Chapter 8 Maintenance

8.1	Maintenance and Care	56
8.2	Cleaning	58

8 Maintenance

Regular, thorough care and appropriate maintenance in particular help to maintain the value of your exercise machine and to extend its lifetime. For this reason, we recommend regular inspections of the machines. Before every use, inspect the machine for damage. If the machine is damaged, have it repaired immediately. These regular inspections are essential in case of guarantee claims.

A safety technology inspection (STI) and measuring technology inspection (MTK) must be performed every 2 years. In Germany, observe §11 of the Medical Devices Operator Ordinance (MPBetreibV). In order to maintain the validity of your warranty, servicing, the STK, and the MTK must be performed by the ERGO-FIT authorized customer service representative. In Germany, documentation in the medical product book is required. As the table operator, ensure adherence to the applicable local regulations.



The following situations make immediate maintenance necessary:

- ⊗ excessive mechanical stress (sharp impact, defect cabling, inappropriate tension),
- ⊗ liquid has entered the device,
- ⊗ cables, connectors or casing are damaged,
- ⊗ covers have dropped off or are damaged.

A safety technology inspection and a measuring technology inspection are always required after service/maintenance work on the device. This is followed by a functional test. Only when the safety inspection, the measuring technology inspection and the functional test have been passed can the proper use of the device be assured.

8.1 Maintenance and Care

ERGO-FIT machines are low-maintenance products. The following chapters outline important inspections and maintenance procedures for different models. You should carry out these tasks regularly.



Switch off and unplug the machine before you perform maintenance tasks or open its casing.

Please note:

- ⊗ Check the device for possible damage every time before use.
- ⊗ In particular, the power cord must be checked for possible damage on a regular basis.
- ⊗ Moving parts need no further oiling or greasing.

Treadle

- ⊗ As screws tend to loosen over time, you should check the treadles and pedals after 3 to 5 operational hours for the first time, then every month. Note that the left pedal has a left-handed thread and the right pedal has a right handed thread.
- ⊗ If a treadle loosens tighten it immediately. Remove the black cap from the crankshaft and retighten the screw underneath with a 14 mm socket spanner. The pedal may be retightened to the crankshaft with a 15 mm open-end spanner.
- ⊗ The SL fuses must also be checked regularly for proper fit, i.e. they must be positioned exactly as shown in the figure.

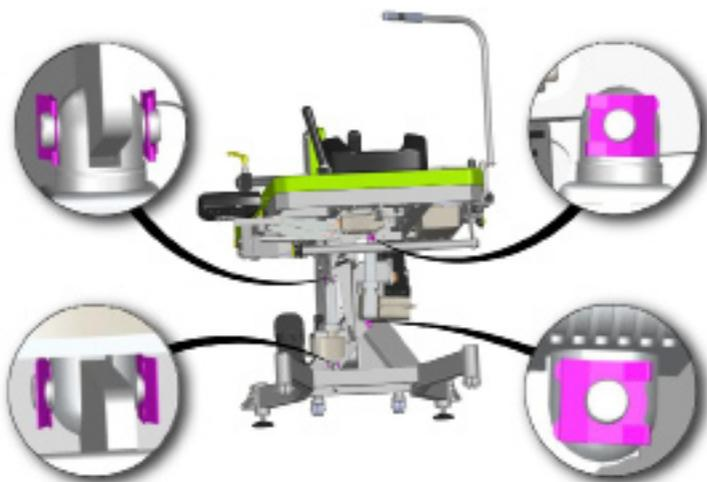
**Blood pressure module**

- ⊗ If the device is equipped with a blood pressure monitor, a metrological control and, if necessary, calibration must be carried out for it no later than every 2 years.
- ⊗ ERGO-FIT recommends replacing the cuff cover every 6 months

SPO₂-module

- ⊗ This module is almost maintenance-free.

8.2 Cleaning

Sweat, dust and dirt can damage your exercise equipment even after a few weeks. Metal and aluminum surfaces may deteriorate when getting into contact with sweat. Therefore you should clean the equipment every day.

We recommend "Ecolab P3-steril" or "Scarabig" for cleaning. You can obtain these detergents at the following suppliers:

Ecolab Deutschland GmbH (www.ecolab.com)

Reisholzer Werftstraße 38-42 / Postfach 13 04 06 - D-40554 Düsseldorf

SCARAPHARM chem.-pharm. Produkte GmbH (www.scarapharm.de)

Wachmannstraße 86 - D-28209 Bremen



Consider the following aspects for cleaning:

Make sure to unplug the machine before cleaning it!

- ⊗ Clean your machine with a damp cloth, mild cleaning agent or soap and dry it with a soft cloth.
- ⊗ Do not apply oil or grease to the external parts of the machine.
- ⊗ Don't use any alcohol-based cleaning agents, aggressive soaps, or bleaching and scouring agents: These products can attack the artificial leather and reduce its service life. .
- ⊗ Use aldehyde-free, alcohol-free surface disinfectants based on tensides or polyhexanide.

Cleaning the blood pressure cuff

Only clean the cuff once you have disconnected it from the blood pressure module.

- ⊗ The cuff can be cleaned with a damp cloth to cleanse the surface of dust and dirt.
- ⊗ Before cleaning the cuff, disconnect the inflation part and microphone from the cuff cover. Before washing it, fold the cover so that the Velcro and hook strap are positioned on top of each other.
- ⊗ The cuff is made of PU and can be washed at 40°C on a gentle cycle with mild detergent. The cuff can be pre-cleaned with a sponge or a soft brush with mild detergent and then rinsed with water. Dry cleaning: treat like delicate clothes.

Disinfecting the blood pressure cuff

The cuff can be treated with the following recommended disinfectants: Cidex, sporicidin, microcid, 70% isopropyl alcohol, 70% ethanol, Buraton liquid. After disinfecting it, rinse the cuff in clear water and allow it to air dry.

Never autoclave the cuff!

The cuff can be cleaned and disinfected multiple times. Should the disinfection procedure result be unsatisfactory, or if the cuff does not look presentable, the cuff cover should be replaced. It is available separately as a spare part.

Preparing for cleaning or replacing the cuff

The cuff consists of a cuff bladder (including microphone, microphone cable and plug, cuff tube and QuickConnect), clamping yoke, strap and cuff cover.

If the cuff cover can no longer be used because of too much dirt, material fatigue or wear, it can be replaced separately, while the other components can still be used.

To clean or replace the cuff cover, open the „adjustable cone“ strap (see Figures 1 & 2).



Fig.1: Closed cuff



Fig.2: Cuff with an open strap

Then pull the strap out of the bracket and open the cuff as shown in Fig.3

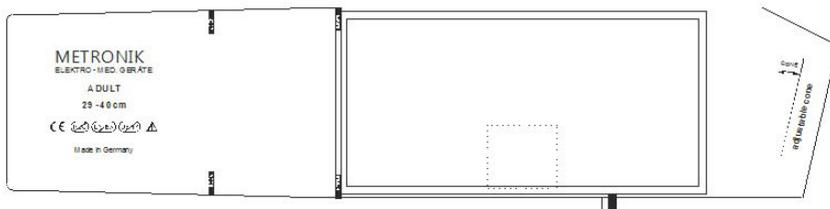

Fig. 3: Sketch of a cuff cover

On the lower right side, the Velcro can be opened up to the tube inlet. Then the cuff bladder can be pulled out to the right, and the clamping yoke can be pulled down from the cuff cover.

Follow the reverse procedure to install a new cuff cover:

First put on the cuff cover as shown in Fig. 3, and then thread the clamping yoke from the right to the far left. Then open the Velcro fastener on the lower right side completely and thread the cuff bladder back into the cover in such a way that the microphone in the bladder is positioned at the level of the marking. The bladder closes flush with the „Index“ marking on the left side. The bladder should be flush, it must not be bent over, twisted or overlapping. If the bladder fits properly, the Velcro fastener can be closed. Finally, the „adjustable cone“ strap is threaded through the clamping yoke and closed with the Velcro.

As described, a cuff cover can also be removed, washed and re-attached to the bladder.

Cleaning the SPO₂ Clips:

Before cleaning the SPO₂ module disconnect the connectors at the control panel.

- ⊗ Clean the sensor with a soft, damp cloth and a mild detergent. The manufacturer recommends Klenzyme by Steris Corporation.
- ⊗ Do not use aggressive disinfectants. Sensors can be damaged. The manufacturer recommends isopropanol (70%) or high level disinfection with CIDEX OPA by Johnson and Johnson Corporation.

Chapter 9 Troubleshooting

9.1	Finding the Error	62
-----	-------------------------	----

9 Troubleshooting

Despite the high quality of ERGO-FIT products malfunctions may occur. In this chapter you find troubleshooting information. If you suspect a technical malfunction do not operate the machine. If you can repair the machine yourself nevertheless inform us of the malfunction. This allows us to record the failure in the model's documentation file and to further improve the quality of our products.



For safety reasons, unplug the machine before work is carried out or the machine is opened!

9.1 Finding the Error

Malfunctions may have simple reasons but sometimes a faulty component is the problem. This chapter provides you with guidelines to resolve possible problems. If the recommendations listed are not successful, please contact our service department immediately. Our service team will be pleased to help you.

Please proceed as follows in case of failure:

The machine does not react (no signal when switching on, empty display)

- ⊗ Check the fuse box. A fuse may be defective or a circuit breaker may have switched off.
- ⊗ Did you use an extension cable or a multi-outlet power strip? Always connect your machine directly to the power socket.
- ⊗ Check the power socket. Plug in another electric device to check the socket.
- ⊗ Pull the power plug out of the socket and visually inspect the power supply cord.

An error message is displayed

- ⊗ Write down the information displayed in the error message.
- ⊗ Check if the error has occurred frequently. If so, when and how often?
- ⊗ Check if multiple electric devices were connected at the same time. If so, which?
- ⊗ Check if a button was pressed when the error message was displayed.
- ⊗ Check if the machine can be started by pressing the START button or if this is possible after complete switch off only.
- ⊗ If you were not present when the error message was displayed, ask the user what exactly happened.
- ⊗ Try to fix the error yourself (see: error messages) or contact the ERGO-FIT service center.

Possible malfunction of the SPO₂ module:

No oxygen measurement

- ⊗ Wrong sensor

SPO₂ measurement returns zero

- ⊗ Operating voltage too high or too low.
- ⊗ Operating temperature too high or too low.
- ⊗ Malfunction because of alternating electric voltage.
- ⊗ Too much ambient light

Possible malfunctions of the blood pressure module:**No pressure build-up possible within 5 seconds after START (pump running)**

- ⊗ no cuff attached ---> connect the cuff
- ⊗ cuff not properly attached ---> check the cuff connector
- ⊗ cuff too loose or not attached ---> put the cuff on tight
- ⊗ cuff leaking ---> change the cuff
- ⊗ leakage in the module ---> servicing required
- ⊗ After module failure ---> perform the metrological control and calibration procedure

No pressure build-up within 5 seconds after START, pump is not running

- ⊗ Control LED does not come on ---> Check power supply, servicing is required
- ⊗ Control LED comes on ---> Check wiring/control panel, servicing is required
- ⊗ Error in the module ---> servicing is required
- ⊗ After module failure ---> perform the metrological control and calibration procedure

No measured values are displayed after the rest measurement

- ⊗ Cuff applied incorrectly, microphone does not detect Korotkoff sounds.
---> See chapter 7.6.
- ⊗ Microphone does not detect Korotkoff sounds.
---> Measure the blood pressure on the other arm
- ⊗ The ERGO filter is set, the Korotkoff sounds are attenuated electronically.
---> reset the ERGO filter. Rest measurement with the ERGO filter is not permitted (see Chapter 7.6.3)
- ⊗ Microphone, microphone cable or microphone plug defective, no sound transmission. Microphone may also be defective due to mechanical fault.
---> Check by tapping the cuff with a finger during the measurement procedure, this will simulate a Korotkoff sound. In case of failure, replace or repair the cuff.
- ⊗ Pressure is released too fast, there are too few Korotkoff noises.
---> Automatic measurement requires at least four consecutive Korotkoff tones. Reduce pressure release rate. (Only possible with BP service program)

The displayed resting blood pressure values are not plausible

- ⊗ The cuff is attached incorrectly, the microphone is not above the artery, Korotkoff sounds are not recorded clearly. See Chapter 7.6.
----> The Korotkoff sounds should be clearly audible in the rest condition and no tube movements should be picked up (see Chapter 7.6.2 and Chapter 7.6.3). (Control over digital beeps)
- ⊗ Wrong cuff size was used.
----> Please select the correct cuff size (see Chapter 7.6.1)
- ⊗ Strong arm movement or the patient talks during the measurement
----> Please perform rest measurement in quiet conditions
- ⊗ Upper arm with the cuff is pressed to upper body during the measurement process.
----> Heart pulsations can be transmitted to the cuff via the upper part of the body and be mistakenly interpreted as Korotkoff sounds.
- ⊗ Pressure is released too fast, cuff pressure difference between two heartbeats is too high.
----> Reduce pressure release rate. (Only possible with BP service program).
Blood pressure value can only be measured at the time of heartbeat. The choice of pressure release rate correlates with the current pulse frequency

Displayed blood pressure values are generally too high

- ⊗ The cuff that was used is too small.
----> Please select the correct cuff size (see Chapter 7.6.1)
- ⊗ Methodological/basic error:
-tube fails during the measurement process,
-arm movement is too strong,
-other loud noise sources in the area
----> The cause of the noise must be looked into.
- ⊗ Is the module defective? ----> Carry out a metrological check

Displayed blood pressure values are generally too low

- ⊗ The cuff that was used is too big.
----> Please select the correct cuff size (see Chapter 7.6.1)
- ⊗ The cuff is incorrectly attached. The microphone is not positioned accurately on the artery, and not all Korotkoff sounds are detected.
----> See chapter 7.6.2.

The displayed active blood pressure values are not plausible

- ⊗ Is the module defective?---> Carry out a metrological check
- ⊗ Resting blood pressure measurement issues.
---> Measuring active blood pressure is only possible when resting blood pressure measurement is taken correctly.
- ⊗ Things to note when putting on the cuff during exercise.
---> The cuff tube must be carefully attached to the arm. An additional cuff strap must also secure the tube at the forearm. The cuff tube should hang freely and should not hit anything during the measurement process.
- ⊗ Special features when using the recumbent bike
---> The upper arm with blood pressure cuff should be spread apart. The cuff must not touch the lying surface or the armrest (noises!). Use arm holder on the recumbent ergometer.
- ⊗ Instructions for the patient.
---> As soon as the patient recognizes that a blood pressure measurement process is about to start, they must keep the arm relaxed, they should not bend or stretch it too much, the cuff must not have any upper body contact. The movement on the ergometer should be even and soft.

The displayed systolic values are too high when active
(At a cuff pressure above systole, the microphone picks up the noise and interprets it as Korotkoff sound)

- ⊗ Methodological/basic error:
-tube fails during the measurement process,
-arm movement is too strong,
-other loud noise sources in the area --->
The cause of the noise must be looked into.
- ⊗ The cuff is attached incorrectly, the microphone is partly not touching the skin.
---> Put the cuff on properly (microphone must be completely in place, and it must not protrude, otherwise it will pick up sounds in the room).

The displayed diastolic values are too low when active
(With a cuff pressure below the diastole, the microphone picks up pulse wave noise or noise and interprets it as Korotkoff sound)..

- ⊗ Methodological/basic error:
 - tube fails during the measurement process,
 - arm movement is too strong,
 - other loud noise sources in the area
- > The cause of the noise must be looked into.

When active, systolic values are too low and diastolic values are too high
(The Korotkoff noise is too low and sounds too quiet)

- ⊗ Cuff microphone is not positioned accurately. ----> See chapter 7.6.1.
- ⊗ The patient has physiologically very quiet Korotkoff sounds; it is also very difficult to take their measurements with a stethoscope .
 - > Measure on the other arm or re-position the microphone.
- ⊗ Pressure release rate is clearly too high.
 - > Reduce the pressure release rate. (Only possible with BP service program)

Blood pressure device was remotely started from the PC, but no measured values were

- ⊗ See "No readings at rest".
 - > If the control panel displays no values, none can be transmitted
- ⊗ Data transfer emulation is not compatible.
 - > Try another combination of protocol selection in the PC ECG and on the control panel of the machine.
- ⊗ Software error.
 - > Try to isolate, understand and document the error. Provide detailed information about the error to the manufacturer/service partner/software developer.

Note: If the BL-6 is integrated into the ECG system, use only the ECG software to start the blood pressure measurement process and not the BP button on the control panel

Chapter A Appendix

A.1	Customer service	70
A.2	Spare Parts	70
A.3	Technical Specification	70
A.4	Electromagnetic Emission and Interference Immunity	72
A.5	Safety Regulations	76
A.5.1	Safety Instructions	76
A.5.2	Mark of Conformity	78
A.5.3	Symbols	78
A.6	Error Margins	80
A.7	Warranty	81
A.8	Entry in Medical Devices Registry	83
	Warnings	87

A Appendix

A.1 Customer Service

If you cannot resolve a malfunction yourself please contact our customer service.

Service: Phone: +49 (6331) 2461-45
+49 (6331) 2461-20
Telefax: +49 (6331) 2461-55
E-Mail: service@ergo-fit.com

ERGO-FIT machines are repaired by highly qualified service technicians. Only original spare parts are used for repairs.

A.2 Spare Parts

For Spare parts and up-to-date exploded views please contact the customer service at ERGO-FIT:

Service: Phone: +49 (6331) 2461-45
+49 (6331) 2461-20
Telefax: +49 (6331) 2461-55
E-Mail: service@ergo-fit.com

Please specify the following:

- ⊗ Model
- ⊗ Serial number
- ⊗ Spare parts name
- ⊗ Spare parts number

A.3 Technical Specification

This chapter lists the technical specifications of your STRESS ECHO X MED

Description	STRESS ECHO X MED
Supply voltage 48-60 Hz	230 V ~
Power input	0,3 A (Ergometer) + 3,7 A (Positioning system)
Fuses	2x 4,0 A T
Power input	6 W (on standby-mode)
Standards & directives	All applied standards and directives you can get on request
Protection class	1/B/IP21 (class/degree/type)
Tested for use in	medical therapy
Accuracy	±5% DIN VDE 750-238
Brake system	Eddy current brake
Inertia	11 +/- 2kg·m ²
Dimensions (in cm)	Length, Ergometer lowered: 205 cm; Ergometer lowered + shoulder support at maximum height: 214 cm, Ergometer raised: 190 cm Width, Cockpit lowered (without hip support): 90 cm, Cockpit raised: 110 cm; Height with speed indicator: 132 cm; about transverse axis (45°): 170 cm Maximum deflection of both axes: 178 cm Table top (L/B/H): 190/78/78 cm
Weight	approx. 210kg
Rpm	20 - 120 rpm
Power Range	15 - 600 W
Increments	5 W
Workout programs	MANUAL, PROFILES, WHO Profiles
Activation	rpm-independent
Max. user weight	200 kg
Interface	RS 232
Specific Equipment	SPO ₂ measurement,
Adjustments possible	Seat height/Seat, Shoulder support, hip support, folding side pad, pedals
Adjustable feet spacing	Width: 68 cm, Length: 113 cm
Adjusting travel	Hip support: horizontal lengthwise 25 cm, horizontal transverse 17 cm, Shoulder support: 31,5 cm; Seat: 25 cm horizontal; Pedal spacing: 36 to 42 cm; Inseam length: 69 to 94 cm
Tilting surfaces	Tilting range 45° over the longitudinal or the transverse axis combined inclination of the longitudinal and transverse axis: max. 30° about the transverse axis and 45° about the longitudinal axis

Description	Blood Pressure Module
Measurement Method	auscultatory, RR method, systole detection at the first Korotkoff sound, diastole detection at the last audible Korotkoff sound (Kotokoff Phase V)
Measurement accuracy	meets or exceeds the requirements of DIN EN ISO 81060-2:2014 for non-invasive accuracy (± 5 mmHg mean deviation, 8 mmHg standard deviation)
Calibration Procedure	Measuring accuracy of BL-6 in terms of pressure and display must be checked every 2 years. (According to the Medical Device Operator Ordinance, a metrological check and, if necessary, a calibration procedure must be performed every 2 years at the latest. Calibration procedure is only required if the machine did not pass the metrological check.)
Systole measuring range	40 - 300 mmHg
Diastole measuring range	30 - 160 mmHg
Pulse measuring range	30 - 230 bpm
Static pressure deviation	max +/- 3 mmHg
Power supply	12 V DC, 1,2 A

A.4 Electromagnetic Emission and Interference Immunity

ERGO-FIT machines were developed in accordance with DIN EN 60601-1-2: 2015 standard for electromagnetic interference, requirements and tests. This standard provides basic safety information and covers the essential performance characteristics in the presence of electromagnetic disturbances and the electromagnetic disturbances emanating from the medical devices, depending on the electromagnetic environment in which the machines are used. Locations for the intended use of ERGO-FIT devices are professional healthcare facilities, except in the vicinity of RF surgical equipment and outside the RF shielded room of a ME system for magnetic resonance imaging, as well as in home healthcare areas (e.g. medical practices that are associated with the public supply network).

As is the case with any electrically operated device, 100% fault-free operation cannot be guaranteed. Interactions or disturbances may occur in certain areas with high intensity interferences. The following warnings should be observed:

WARNING:

- ⊗ Danger of malfunction!
 Avoid operating the machine immediately next to other devices or when stacked with other devices. If such use becomes necessary, ERGO-FIT equipment and other equipment must be monitored to ensure proper operation.
- ⊗ Possibility of increased electromagnetic emissions and reduced electromagnetic immunity of this device! Danger of malfunction! Do not use accessories or cables

other than those specified or supplied by the manufacturer. (12-volt line for the blood pressure module, machine connection cable, interface cable (network))

- ⊗ Deteriorated performance of the machine!
Portable RF communications equipment (including such accessories as antenna cables and external antennas) must be at least 30 cm (12 inches) away from any part of the ERGO-FIT system, including the cables specified by the manufacturer.

If electromagnetic interference should occur in connection with a device, we recommend the following measures:

- ⊗ Change the orientation or location of the neighboring device.
- ⊗ Increase the distance between the devices.
- ⊗ Connect the monitor and the other devices to sockets of different circuits.
- ⊗ Contact the manufacturer or a service technician.

These guidelines may not apply in all situations. Electromagnetic propagation is affected by absorption and reflection from structures, objects and people.

Electromagnetic emission and immunity, compliance and test level

ERGO-FIT products are intended for use in the areas specified above. Please make sure to only use the product in appropriate environments. The product uses HF processes only for internal functions. Since the machine complies with the requirements of class B, its RF emissions are rather low, and it is unlikely that neighboring electronic devices will be affected. When determining the limit values according to DIN EN 61000-3-2, it is assumed that the device is used professionally.

Electromagnetic Interference Measurements	Required < Criterion	Observed < Criterion
RF emissions in compliance with CIS-PR 11, German version in compliance with DIN EN 55011, conducted radio interference voltage	Class B	Class B
RF emissions in compliance with CIS-PR 11, German version in compliance with DIN EN 55011, radiated radio interference voltage	Class B	Class B
Distortion due to harmonics in compliance with IEC 61000-3-2	Class A	Met
Voltage fluctuations and flicker in compliance with IEC 61000-3-3	Pt < 1	Pt < 1

Electromagnetic interference immunity, compliance and test level

Electromagnetic Interference immunity Measurements	Required	Observed
Static electricity discharge (ESD) in compliance with IEC 61000-4-2	Contact ± 8 kV Air ± 2 kV, ± 4 kV, ± 8 kV, ± 15 kV	Contact ± 8 kV Air ± 15 kV
RF radiation in compliance with IEC 61000-4-3	3 V/m or 10 V/m 80 MHz to 2.7 GHz	10 V/m 80 MHz to 2.7 GHz
RF radiation in the immediate vicinity of wireless communication devices in compliance with IEC 61000-4-3	see the following table	see the following table
Magnetic field for supply frequency (50/60 Hz) in compliance with IEC 61000-4-8	30 A/m 50Hz or 60Hz	100 A/m 50 Hz
Fast transient electrical disturbances/bursts in compliance with IEC 61000-4-4	+/- 2 kV / 100 kHz repetition frequency for power cable	+/- 2 kV / 100 kHz repetition frequency for power cable
Surges in compliance with IEC 61000-4-5	Line - Line: ± 0.5 kV, ± 1 kV Line - PE: ± 0.5 kV, ± 1 kV, ± 2 kV	Line - Line: ± 0.5 kV, ± 1 kV Line - PE: ± 0.5 kV, ± 1 kV, ± 2 kV
Conducted RF interference in compliance with IEC 6100-4-6	6 Vrms 150 kHz to 80 MHz	6 Vrms 150 kHz to 80 MHz
Voltage dips, brief voltage interruptions and voltage fluctuation in compliance with IEC 61000-4-11	30 % 10ms \rightarrow B 60 % 100 ms \rightarrow C >98 % 5000ms \rightarrow C	30 % 10ms \rightarrow A 60 % 100 ms \rightarrow A >98 % 5,000ms \rightarrow A

Immunity to wireless communication devices (according to IEC 61000-4-3/DIN EN 61000-4-3, RF radiation)					
Test Frequency	Range (MHz) Service	Max. Power (W)	Distance (m)	Test level required (V/m)	Test level achieved (V/m)
385	380 – 390 TETRA 400	1.8	0,3	27	28
450	430 – 470 GMRS 460, FRS 460	2	0,3	28	28
710 745 780	704 – 787 LTE Band 13, 17	0,2	0,3	9	9
810 870 930	800 – 960 GSM 800 /900, TE- TRA 800, iDEN 820, CDMA 850, LTE Range 5	2	0,3	28	28
1720 1845 1970	1700 – 1990 GSM 1800, CDMA 1900, GSM 1900, DECT, LTE Range 1, 3, 4, 25, UMTS	2	0,3	28	28
2450	2400 – 2570 Bluetooth, WLAN 802.11 b/g/n, RFID 2450, LTE Range 7	2	0,3	28	28
5240 5500 5785	5100 – 5800 WLAN 802.11 a/n	0,2	0,3	9	9

A.5 Safety Regulations

A.5.1 Safety Instructions

For user safety the VDE (Verband der Elektrotechnik e.V.) has issued special instructions for medical premises and electro-medical devices.

According to these instructions, devices with mains connection must be equipped not only with a reliable insulation of live parts but also with an additional protective measure to protect the user against the transfer of the supply voltage to touchable metal parts. For this purpose, VDE subdivides so-called protection classes.

Of the protection classes allowed for electro-medical devices, in most cases protection class I (protective measures with protective earth conductor) as well as protection class II (protective measures without protective earth conductor but double insulation) are used: In protection class I devices, metal casing parts are connected with the protective earth conductor of the grid through its earthing contact. In case of insulation failure, the upstream circuit breaker will close the circuit.

The ERGO-FIT device of the STRESS ECHO X MED is classified as protection class I devices.

The use of electro-medical devices is restricted to safety-relevant innocuousness taking account of the state of the art, health and safety regulations and accident prevention. Protective measures must be taken to avoid both direct and indirect contact. Covers, coatings, insulation of energized parts in combination with protective measures using protective earth conductors (in compliance with protection class I), melting fuses, as well as the observation of distances between devices are all part of this.

For ERGO-FIT machines the most suitable distance to be maintained is 1.5 meters. With this distance, two training devices cannot be connected conductively by a person and it is unlikely that users will receive an electric shock during workout.

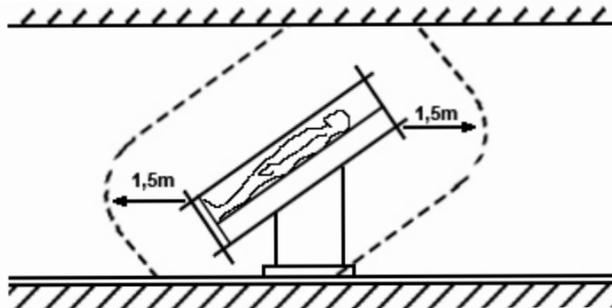
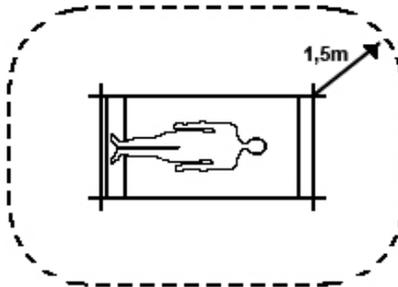

The instructions in this chapter refer to the German safety model. These instructions may vary in other countries.

A.5.2 Mark of Conformity

The ERGO-FIT STRESS ECHO X MED is manufactured in accordance with highest safety and quality standards and are designed for commercial use.

All standards and directives applied during the development are listed in the declarations of conformity which you can get on request.

On the machine's type label you can find the information listed in the below:

 12345678910111213  ERGO-FIT GmbH & Co. KG Blocksbergstraße 165 GER-66955 Pirmasens Baujahr  IP 21  	CE 0297 EN20957 SA  	article number		CE mark	
	SerienNR 100 V-230 V ~48-60 Hz	??? AL, ??? V 	manufacturer	address	EV 20957 SA Please note user manual
	??? A- ??? A 	MAX ??? kg 	year of manufacture	serial number	
			UDI	power supply	fuse
			IP class		
			electric waste		max. user weight
			protection class type B	power input	max. training weight

A.5.3 Symbols

The symbols used for ERGO-FIT machines comply with the IEC 417 and IEC 878 standards. The following symbols are used on the machine:

	Alternate current		Serialnumber of the machine
	Protective earth conductor (in the machine)		Order number
	Potential equalization		Date of manufacture
	Grounded		Manufacturer



Hazardous electrical voltage



Off (supply connection)



On (supply connection)



Type B classified

IP21

Protection class through housing (IP code) (Contact protection: with finger
Foreign matter protection: medium-sized objects (diameter greater than
12.5 mm). Water protection: Water dripping vertically



Please note user manual



Electrical waste (Disposal of the device in regular clinic waste is prohibited.
For more information on disposal, please contact your authorized distributor or
the manufacturer)



CE marking with identification number of the notified body. The product meets
the fundamental requirements of the Medical Device Directive 93/42/EEC

The following symbols are used on the packaging:



Top side



Fragile



Keep dry



Do not roll



Note center of gravity

RH

Allowable temperature range

P

Allowable relative humidity range



Allowable ambient pressure range

A.6 Error Margins

In compliance with DIN VDE 0750-238 the following error margins apply for STRESS ECHO X MED:

1. The read-out error for power (p) may not exceed $\pm 5\%$ of the displayed value. It may not fall below $\pm 3W$.
2. The read-out error for speed (n) is set to a maximum of $\pm 2 \text{ min}^{-1}$ above 40 min^{-1} .
3. The measurement device to assess the output calculated on the base of brake torque and rotational speed of the treadle ergometer must not exceed an error margin of 1% .

The following figure shows the characteristic curve of the brake torque control:

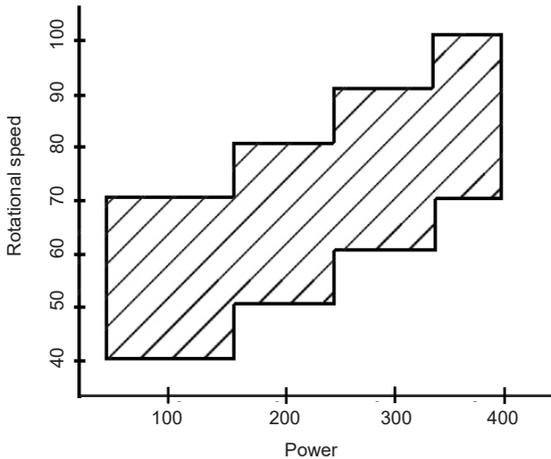

The work capacity is displayed as follows:

Display right of rpm/speed	VDE 750-238
n/a	5% range
Points	10% range
Arrows	Deviation > 10%

A.7 Warranty

2-year warranty (see general terms and conditions, point 8.1 guarantee „ERGO-FIT grants 2 years guarantee for its own products. In the first year the travel expenses and occurring working hours within Germany are borne in addition to the spare parts. In the second year only the spare parts. For merchandise the guarantee provisions of the respective manufacturer apply accordingly“)

The supplier shall be liable for defects of the supply, among them the lack of expressly assured properties, but excluding further claims as follows:

1. All those parts showing to be unserviceable or to be essentially restricted in their usability within a period of 24 months after delivery, by circumstances to be traceable prior to the transmission of risks - especially due to faulty design, bad quality of the material or faulty manufacture - shall be repaired or replaced, at the own discretion of the supplier. The decision if the fault may be repaired or should be replaced will be at the seller's discretion.
2. The limitation of the purchaser's right to claim for defects shall be 24 months after transfer of the object in every and each case.
3. No warranty is offered for damage that arises for the following reasons: inappropriate or improper use, faulty assembly or faulty startup carried out by the purchaser or a third party, natural wear, faulty or careless handling, inappropriate equipment or replacement materials, faulty construction works, chemical, electrochemical or electric influences, except in the event that they are due to the supplier's fault. Purchaser shall bear the expense and the risk of the delivery even if delivery freight paid has been agreed.
4. The supplier reserves the right of two reworks or replacements. Should these fail, the purchaser has the right of reduction or conversion within the framework of legal provisions. The seller will have a period of six weeks for reworks, beginning with the notice of defect.
5. Improper modifications or repairs carried out by the purchaser or a third party without prior permission of the supplier will void the warranty.
6. If goods are exported, warranty will be restricted to the availability of loose spare parts ex factory within the warranty period. Packaging costs, freight charges and labor will be at the expense of the purchaser. In case the purchaser demands on-site repair by a technician of the factory or another service center, the purchaser will bear the travelling expenses and labor costs.
7. All merchandise that has not been produced by the supplier is subject to legal Provisions.

Wear parts such as those listed below are excluded for warranty:

- ⊗ Pedals
- ⊗ Pedal straps
- ⊗ Seat
- ⊗ Head support
- ⊗ Hip support
- ⊗ Driving belt
- ⊗ Adjusting Lever
- ⊗ Fuses
- ⊗ Sensor SPO₂-module
- ⊗ Freewheel
- ⊗ Cuff blood pressure module
- ⊗ Cable blood pressure module

Improper maintenance will void the warranty!

A.8 Entry in Medical Devices Registry

In compliance with §11 section 7 and §7 of the regulation on the erection, operation, and use of medical devices („MPBetreibV“) as of June 29, 1998 (BGBt 1. p. 1762), the person who carries out metrological controls must immediately record the measured values, the measuring method, as well as other evaluation results into the registry of medical devices. As during metrological control of your medical device the registry of medical devices was not available, we ask you to use the following data for your documentation.

Operator:

Facility: _____

Contact: _____

Address: _____

Zip, City: _____

Manufacturer:

ERGO-FIT GmbH & Co. KG, Blocksbergstraße 165, D-66955 Pirmasens

Device Identification

Device name: _____

Model: _____

Serial-number: _____

Measuring method and evaluation:

- Guide to metrological controls (LMK)
- Appendix 15 or Appendix 23 of calibration regulations (EQ 15 or EQ 23)
- Remarks: _____

Used standards: _____

Measured values see following page(s)

- Metrological control i.o.; annual designation of sealing:
- Metrological control not i.o.; **old sealing obliterated**

Signature

Measuring method and evaluation:

- Guide to metrological controls (LMK)
- Appendix 15 or Appendix 23 of calibration regulations (EQ 15 or EQ 23)
- Remarks: _____

Used standards: _____

Measured values see following page(s)

- Metrological control i.o.; annual designation of sealing:
- Metrological control not i.o.; **old sealing obliterated**

Signature

Measuring method and evaluation:

- Guide to metrological controls (LMK)
- Appendix 15 or Appendix 23 of calibration regulations (EQ 15 or EQ 23)
- Remarks: _____

Used standards: _____

Measured values see following page(s)

- Metrological control i.o.; annual designation of sealing:
- Metrological control not i.o.; **old sealing obliterated**

Signature

Registration of medical devices add-in card**Operator:**

1. Designation of the medical device:

2. Functional test and introduction:

Functional test carried out

on: _____ by: _____

Introduction carried out

on: _____ by: _____

Introduces person: _____

3. Metrological controls: at least every two years

next inspection: _____

by (person's name): _____

4. Maintenance and safety inspection (subject to MPBetreibV): recomm. every 12 months

next inspection: _____

by (person's name): _____

5. Date, type and consequence of the defect and repeated identical operating fault:

6. Reports of incidents to authorities and manufacturer:

Warnings

STRESS ECHO X MED

- ⊗ Read the user manual carefully before you start.
- ⊗ Before starting the exercise please check the power supply cord.
- ⊗ Check the wiring to external devices prior to workout.
- ⊗ Always connect the equipment to the power supply before using it and only use it after a proper functional test.
- ⊗ Ensure that the power cords cannot be driven over.
- ⊗ Check whether all locking pins for the adjusting mechanisms and pads are locked before the patient uses the device .
- ⊗ The machine is only to be used on the instruction of a physician and / or a supervisor. The machine must not be used without the presence of a supervisor.
- ⊗ In case of nausea or dizziness, the patient has to stop training immediately and see a physician.
- ⊗ Persons who wear a cardiac pacemaker or have health problems consult a physician before using the machine.
- ⊗ Your patients have to wear only appropriate clothing and footwear during workout.
- ⊗ Advise your patient, not to take the feet off the pedals or jump from the machine during the training
- ⊗ Only use the tilting mechanism with the adjustable feet locked .
- ⊗ Ensure that the tilting mechanism is only used with the hip support in place in order to avoid damage to health.
- ⊗ Ensure a sufficient safety clearance before using the tilting mechanism.
- ⊗ In order to avoid injuries, talk to the patient before adjusting the seat and maintain eye contact with the patient while adjusting the seat.
- ⊗ Don't lean on the cockpit or on the device covers, and don't perform any improper movements on the device .
- ⊗ Switch off the machine after the workout and disconnect it..
- ⊗ Children must not use the machine without supervision and must keep away from the machine and its moving parts.
- ⊗ Before every use, check the moving parts and the casing for damage. If the machine is damaged, have it repaired immediately.
- ⊗ Do not cover the ventilation louvers. This can cause the machine to overheat.
- ⊗ Don't open any drives or controllers as this would void the warranty.
- ⊗ Repairs to energized parts may only be performed by a specialist using original spare parts.
- ⊗ Do not touch the USB port, RS232 port or audio port or the connection SPO2 measurement during the training

- ⊗ When changing the fuse you should not touch the internal contacts of the fuse switch in the power plug.
- ⊗ Note: Do not exceed the maximum user weight of 200 kg.
- ⊗ Prevent improper use of the equipment.
- ⊗ Please also read any further safety instruction and warnings in this manual.

All safety instructions in this manual are based on many years of experience and self-conception.

*These safety instruction must be visible at the cardio exercise machine!
All users must be informed of warnings and safety instructions.
The manufacturer will not be liable for personal injuries or property damage.*

ERGO▶FIT

ERGO-FIT GmbH & Co. KG

Blocksbergstraße 165 – D-66955 Pirmasens
Phone: +49 (6331) 2461-0 – Fax: +49 (6331) 2461-55
info@ergo-fit.de – www.ergo-fit.de